

ROBBE & BERKING

SILBER



Catalogue – Cutlery · Table Accessories · Gift Items
Catalogue – Couverts · Accessoires de table · Cadeaux
Catálogo – Cuberterías · Objetos de mesa · Artículos de regalo
Catalogo – Posate · Accessori Tavola · Articoli da regalo

01.06.2026



ROBBE & BERKING

ROBBE & BERKING

Content | Index | Contenido | Indice











	Page
Silver and massive silver plated cutlery Couverts argent massif et argentés Cuberterías de plata y con baño de plata Posate d'argento e in lega argentate	4 – 7
Gilding Dorure Baño Doratura	8
Table napkin rings Ronds de serviette Servilleteros Portatovaglioli	9
Shape and size of individual pieces La forme et la taille des pièces individuelles Forma y tamaño de las piezas Forma e misura dei singoli pezzi	10 – 13
Children's sets Couverts pour enfants Cubiertos infantiles Posate per bambini	14 – 15
Silver care products/canteens Entretien et entreposage d'argenterie Cuidado y conservación de plata Prodotti per la manutenzione di oggetti in argento	16 – 17
Sets Garnitures Adornos Servizi	17
Stainless steel cutlery Couverts acier massif Cuberterías acero inoxidable Posate Inox 18/8	18 – 19
Bar Collection Bar Collection Colección del bar Collezione da bar	20 – 27
Bar Cart Chariot de bar Carro de bar Carrello bar	28 – 29
The Box Champagne Box	30
Barbecue Collection Barbecue collection Colección Barbacoa Collezione barbecue	31
Gourmet Collection Collection gourmet Colección gourmet Collezione gourmet	32
Table accessories and gift items Accessoires de table et cadeaux Objetos de mesa/Artículos de regalo Accessori tavola/Articoli da regalo	33 – 53
Games Jeux Juegos Giochi	54 – 55
Service plates and trays Assiettes et plateaux Platos y bandejas Piatti e vassoi	56
X-Mas/Easter decoration Décoration arbre Noël/Pâque Decoraciones de Navidad/Pascua Decorazioni natalizie/pasquali	57
Engravings Gravures Grabados Incisioni	58
Customised knife blades Lames de couteau personnalisées Hojas de cuchillo personalizadas Lame di coltello personalizzate	59
Repairs Réparations Reparaciones Riparazioni	60
Material and Quality Matériaux et qualité Material y calidad Materiale e qualità	61

All dimensions and weights in this price list are approximate and for guidance only.
Minor deviations are possible and due to manufacture.

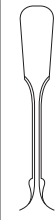
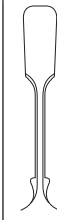
Toutes les dimensions et poids indiqués dans cette liste de prix sont approximatifs et ne sont donnés qu'à titre indicatif.
Des écarts mineurs sont possibles en raison de la manufacture.











Todos los pesos y medidas en esta lista de precios son solamente datos aproximados y sirven únicamente como guía.
Tolerancias pequeñas son relacionadas a la producción.

Tutte le dimensioni e i pesi citati in questo listino prezzi sono approssimativi e servono solo come guida.
Deviazioni minori sono possibili a causa del processo di fabbricazione.

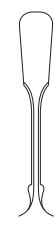
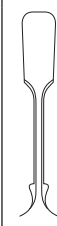
EN SILVER AND MASSIVE SILVER PLATED CUTLERY FR COUVERTS ARGENT MASSIF ET ARGENTÉS												
		062	073	044	048	020	019	053	050	068	063	046
		Dante	Metropolitan*	Avenue*	Navette	Spaten	Alt-Spaten	Alt-Chippendale*	Alta	Belvedere*	Martelé	Französisch-Perl*
												
Price category		03	925 Sterling Silver									
Catégorie de prix		02	150 massive silver plated									
Art. No.	Art. Nr.											
004	Menu spoon Cuiller à menu	●	●	●	●	●	●	●	●	●	●	●
005	Menu fork Fourchette à menu	●	●	●	●	●	●	●	●	●	●	●
006	Menu knife Couteau à menu	●	●	●	●	●	●	●	●	●	●	●
106	Menu knife Couteau à menu – Frozen Black									●	●	●
001	Table spoon Cuiller de table			●	●	●			●			
002	Table fork Fourchette de table			●	●	●			●			
003	Table knife Couteau de table			●	●	●			●			
007	Dessert spoon Cuiller à dessert	●	●	●	●	●	●	●	●	●	●	●
008	Dessert fork Fourchette à dessert	●	●	●	●	●	●	●	●	●	●	●
009	Dessert knife Couteau à dessert	●	●	●	●	●	●	●	●	●	●	●
020	Coffee spoon, large Cuiller à café, grand	●	●	●	●	●	●	●	●	●	●	●
021	Coffee spoon Cuiller à café	●	●	●	●	●	●	●	●	●	●	●
022	Tea spoon III Cuiller à thé											
023	Mocha-/espresso spoon Cuiller à moka	●	●	●	●	●	●	●	●	●	●	●
027	Cake fork, large Fourchette à gâteaux, grande	●	●	●	●	●	●	●	●	●	●	●
068	Cake knife Couteau à gâteaux	●	●	●	●	●	●	●	●	●	●	●
028	Oyster fork Fourchette à huîtres	●	●	●	●	●	●	●	●	●	●	●
083	Butter spreader Tartineur	●	s.Art. 068	●	●	●	●	●	●	s.Art. 068	s.Art. 068	●
026	Ice-cream spoon Cuiller à glace	s.Art. 020	●	●	●	●	●	●	●	s.Art. 020	●	●
010	Fish knife Couteau à poisson	●	●	●	●	●	●	●	●	●	●	●
011	Fish fork Fourchette à poisson	●	●	●	●	●	●	●	●	●	●	●
097	Gourmet spoon Cuiller gourmet	●	●	●	●	●	●	●	●	●	●	●
029	Lobster fork Fourchette à homard		●	●	●	●	●	●	●			●
084	Steak knife Couteau à steak	●	●	●	●	●	●	●	●	●	●	●
184	Steak knife Frozen Black Couteau à steak – Frozen Black									●	●	●
025	Broth spoon Cuiller à consommé	●	●	●	●	●	●	●	●	●	●	●
091	Butter knife, hollow handle Couteau à beurre, lame inox	●	●	●	●	●	●	●	●	●	●	●
092	Cheese knife, hollow handle Couteau à fromage, lame inox	●	●	●	●	●	●	●	●	●	●	●
045	Fish serving knife Couteau à servir le poisson	●	●	●	●	●	●	●	●	●	●	●
046	Fish serving fork Fourchette à servir le poisson	●	●	●	●	●	●	●	●	●	●	●
031	Meat fork, large Fourchette à viande, grande	●	●	●	●	●	●	●	●	●	●	●
032	Meat fork, small Fourchette à viande, petite			●	●	●	●	●	●			●
050	Pastry server Pelle à gâteaux			●	●	●	●	●	●			●
038	Serving fork Fourchette à servir	●	●	●	●	●	●	●	●	●	●	●
039	Serving spoon Cuiller à servir	●	●	●	●	●	●	●	●	●	●	●
044	Serving spoon, large Cuiller à servir, grand	●	●	●	●	●	●	●	●	●	●	●
014	Children's spoon Cuiller pour enfants			●	●	●	●	●	●		s.Art. 026	●
015	Children's fork Fourchette pour enfants			●	●	●	●	●	●		●	●
016	Children's knife Couteau pour enfants			●	●	●	s.Art. 068	s.Art. 068	●		s.Art. 068	●
086	Pierced spoon Cuillère percée											
025	Cream spoon Cuiller à crème	●	●	●	●	●	●	●	●	●	●	●
061	Cream spoon, bent Cuiller à crème, cintrée				●	●						
040	Salad spoon, large Cuiller à servir la salade, grande	●	●	●	●	●	●	●	●	●	●	●
041	Salad fork, large Fourchette à servir la salade, grande	●	●	●	●	●	●	●	●	●	●	●
042	Salad spoon, small Cuiller à servir la salade, petit	●	●	●	●	●	●	●	●	●	●	●
043	Salad fork, small Fourchette à servir la salade, petit	●	●	●	●	●	●	●	●	●	●	●
035	Sauce ladle Cuiller à sauce	●	●	●	●	●	●	●	●	●	●	●
019	Table napkin ring Rond de serviette	●	●	●	●	●	●	●	●	●	●	●
047	Asparagus server Pelle à asperges	●	●	●	●	●	●	●	●	●	●	●
087	Asparagus tongs Pince à asperges											
036	Soup ladle Louche	●	●	●	●	●	●	●	●	●	●	●
052	Tart server Pelle à tarte	●	●	●	●	●	●	●	●	●	●	●
054	Tart knife Couteau à tarte	●	●	●	●	●	●	●	●	●	●	●
048	Carving knife Couteau à découper	●	●	●	●	●	●	●	●	●	●	●
049	Carving fork Fourchette à découper	●	●	●	●	●	●	●	●	●	●	●
148	Carving knife Couteau à découper – Frozen Black						●	●	●	●	●	●
149	Carving fork Fourchette à découper – Frozen Black						●	●	●	●	●	●
064	Sugar spoon Cuiller à sucre	●	●	●	●	●	●	●	●	●	●	●
065	Sugar tongs Pince à sucre	●	●	●	●	●	●	●	●	●	●	●

064	038	040	055	010	070	057	071	056	045	060	072	069	061		Art. No. Art. Nr.	
Riva	Rosemmuster*	Alt-Kopenhagen	Viva	Ostfresen*	Hermitage*	Classic-Faden*	Eclipse	Arcade*	Alt-Faden	Art Deco*	I2	Sphinx	Glo*			
2	2	2	2	2	2	3	3	3	3	3	3	3	3			
2	3	3	3	3	3	2	2	3	3	3	3	3	3			
●	●	●	●	●	●	●	●	●	●	●	●	●	●	●	Menu spoon Cuiller à menu	004
●	●	●	●	●	●	●	●	●	●	●	●	●	●	●	Menu fork Fourchette à menu	005
●	●	●	●	●	●	●	●	●	●	●	●	●	●	●	Menu knife Couteau à menu	006
●														●	Menu knife Couteau à menu – Frozen Black	106
				●						●					Table spoon Cuiller de table	001
				●						●					Table fork Fourchette de table	002
				●						●					Table knife Couteau de table	003
●	●	●	●	●	●	●	●	●	●	●	●	●	●	●	Dessert spoon Cuiller à dessert	007
●	●	●	●	●	●	●	●	●	●	●	●	●	●	●	Dessert fork Fourchette à dessert	008
●	●	●	●	●	●	●	●	●	●	●	●	●	●	●	Dessert knife Couteau à dessert	009
	●	●	●	●	●	●	●	●	●	●	●	●	●	●	Coffee spoon, large Cuiller à café, grand	020
●	●	●	●	●	●	●	●	●	●	●	●	●	●	●	Coffee spoon Cuiller à café	021
				●											Tea spoon III Cuiller à thé	022
●	●	●	●	●	●	●	●	●	●	●	●	●	●	●	Mocha-/espresso spoon Cuiller à moka	023
●	●	●	●	●	●	●	●	●	●	●	●	●	●	●	Cake fork, large Fourchette à gâteaux, grande	027
●	●	●	●	●	●	●	●	●	●	●	●	●	●	●	Cake knife Couteau à gâteaux	068
	●	●		●	●	●		●	●	●				●	Oyster fork Fourchette à huitres	028
s. Art. 068	●	●		●	●	●	s. Art. 068	●	●	●		s. Art. 068			Butter spreader Tartineur	083
s. Art. 064	●	●	s. Art. 064	●	●	●	●	●	●	●	s. Art. 064	s. Art. 020	●		Ice-cream spoon Cuiller à glace	026
●	●	●	●	●	●	●	●	●	●	●	●	●	●	●	Fish knife Couteau à poisson	010
●	●	●	●	●	●	●	●	●	●	●	●	●	●	●	Fish fork Fourchette à poisson	011
●	●	●	●	●	●	●	●	●	●	●	●	●	●	●	Gourmet spoon Cuiller gourmet	097
●	●	●	●	●	●	●	●	●	●	●	●	●	●	●	Lobster fork Fourchette à homard	029
●	●	●	●	●	●	●	●	●	●	●	●	●	●	●	Steak knife Couteau à steak	084
●	●	●	●	●	●	●	●	●	●	●	●	●	●	●	Steak knife Frozen Black Couteau à steak – Frozen Black	184
●	●	●	●	●	●	●	●	●	●	●	●	●	●	●	Broth spoon Cuiller à consommé	025
●	●	●	●	●	●	●	●	●	●	●	●	●	●	●	Butter knife, hollow handle Couteau à beurre, lame inox	091
●	●	●	●	●	●	●	●	●	●	●	●	●	●	●	Cheese knife, hollow handle Couteau à fromage, lame inox	092
●	●	●	●	●	●	●	●	●	●	●	●	●	●	●	Fish serving knife Couteau à servir le poisson	045
●	●	●	●	●	●	●	●	●	●	●	●	●	●	●	Fish serving fork Fourchette à servir le poisson	046
●	●	●	●	●	●	●	●	●	●	●	●	●	●	●	Meat fork, large Fourchette à viande, grande	031
●	●	●	●	●	●	●	●	●	●	●	●	●	●	●	Meat fork, small ditto, petite	032
	●	●	●	●	●	●	●	●	●	●				●	Pastry server Pelle à gâteaux	050
●	●	●	●	●	●	●	●	●	●	●	●	●	●	●	Serving fork Fourchette à servir	038
●	●	●	●	●	●	●	●	●	●	●	●	●	●	●	Serving spoon Cuiller à servir	039
●	●	●	●	●	●	●	●	●	●	●	●	●	●	●	Serving spoon, large Cuiller à servir, grand	044
	●	●		●		●						s. Art. 025			Children's spoon Cuiller pour enfants	014
	●	●		●		●						●			Children's fork Fourchette pour enfants	015
	●	●		●		s. Art. 068			●			s. Art. 068			Children's knife Couteau pour enfants	016
●	●	●	●	●	●	●	●	●	●	●	●	●	●	●	Pierced spoon Cuillère percée	086
	●			●	●									●	Cream spoon Cuiller à crème	025
				●	●										Cream spoon, bent Cuiller à crème, cintrée	061
●	●	●	●	●	●	●	●	●	●	●	●	●	●	●	Salad spoon, large Cuiller à servir la salade, grande	040
●	●	●	●	●	●	●	●	●	●	●	●	●	●	●	Salad fork, large Fourchette à servir la salade, grande	041
	●	●	●	●	●	●	●	●	●	●	●	●	●	●	Salad spoon, small Cuiller à servir la salade, petit	042
				●	●	●	●	●	●	●	●	●	●	●	Salad fork, small Fourchette à servir la salade, petit	043
●	●	●	●	●	●	●	●	●	●	●	●	●	●	●	Sauce ladle Cuiller à sauce	035
●	●	●	●	●	●	●	●	●	●	●	●	●	●	●	Table napkin ring Rond de serviette	019
	●	●	●	●	●	●	●	●	●	●	●	●	●	●	Asparagus server Pelle à asperges	047
●	●	●	●	●	●	●	●	●	●	●	●	●	●	●	Asparagus tongs Pince à asperges	087
●	●	●	●	●	●	●	●	●	●	●	●	●	●	●	Soup ladle Louche	036
●	●	●	●	●	●	●	●	●	●	●	●	●	●	●	Tart server Pelle à tarte	052
●	●	●	●	●	●	●	●	●	●	●	●	●	●	●	Tart knife Couteau à tarte	054
●	●	●	●	●	●	●	●	●	●	●	●	●	●	●	Carving knife Couteau à découper	048
●	●	●	●	●	●	●	●	●	●	●	●	●	●	●	Carving fork Fourchette à découper	049
●	●	●	●	●	●	●	●	●	●	●	●	●	●	●	Carving knife Couteau à découper – Frozen Black	148
●	●	●	●	●	●	●	●	●	●	●	●	●	●	●	Carving fork Fourchette à découper – Frozen Black	149
●	●	●	●	●	●	●	●	●	●	●	●	●	●	●	Sugar spoon Cuiller à sucre	064
●	●	●	●	●	●	●	●	●	●	●	●	●	●	●	Sugar tongs Pince à sucre	065



ES CUBERTERÍAS DE PLATA Y CON BAÑO DE PLATA IT POSATE D'ARGENTO E ARGENTATE		062	073	044	048	020	019	053	050	068	063	046
		Dante	Metropolitan*	Avenue*	Navette	Spaten	Alt-Spaten	Alt-Chippendale*	Alta	Belvedere*	Martelé	Französisch-Perl*
												
Categoría de precios		03	925 Argento Sterling									
Fascia di prezzo		02	150 Argentatura forte									
Ref. Art. no.												
004	Cuchara mesa Cucchiaino tavola	●	●	●	●	●	●	●	●	●	●	●
005	Tenedor mesa Forchetta tavola	●	●	●	●	●	●	●	●	●	●	●
006	Cuchillo mesa Coltello tavola	●	●	●	●	●	●	●	●	●	●	●
106	Cuchillo mesa Coltello tavola – Frozen Black									●	●	
001	Cuchara banquete Cucchiaino tavola, grande			●	●	●			●			
002	Tenedor banquete Forchetta tavola, grande			●	●	●			●			
003	Cuchillo banquete Coltello tavola, grande			●	●	●			●			
007	Cuchara postre/entremés Cucchiaino frutta	●	●	●	●	●	●	●	●	●	●	●
008	Tenedor postre/entremés Forchetta frutta	●	●	●	●	●	●	●	●	●	●	●
009	Cuchillo postre/entremés Coltello frutta	●	●	●	●	●	●	●	●	●	●	●
020	Cuchara café, grande Cucchiaino tè e colazione	●	●	●	●	●	●	●	●	●	●	●
021	Cuchara café Cucchiaino caffè-tè	●	●	●	●	●	●	●	●	●	●	●
022	Cuchara té Cucchiaino tè											
023	Cuchara moca Cucchiaino moca/espresso	●	●	●	●	●	●	●	●	●	●	●
027	Tenedor tarta Forchetta dolci	●	●	●	●	●	●	●	●	●	●	●
068	Tenedor ostras Forchetta ostriche	●	●	●	●	●	●	●	●	●	●	●
028	Cuchillo de mantequilla Coltello burro	●	●	●	●	●	●	●	●	●	●	●
083	Cuchara helado Cucchiaino gelato	●	s. Art. 068	●	●	●	●	●	●	s. Art. 068	s. Art. 068	●
026	Cuchillo pescado Coltello pesce	s. Art. 020	●	●	●	●	●	●	●	s. Art. 020	●	●
010	Tenedor pescado Forchetta pesce	●	●	●	●	●	●	●	●	●	●	●
011	Cuchara gourmet Cucchiaino salsa individuale	●	●	●	●	●	●	●	●	●	●	●
097	Tenedor de marisco Forchetta aragosta	●	●	●	●	●	●	●	●	●	●	●
029	Cuchillo fruta Coltello dolci		●	●	●	●	●	●	●			●
084	Cuchillo steak Coltello bistecca	●	●	●	●	●	●	●	●	●	●	●
184	Cuchillo steak Coltello bistecca – Frozen Black									●	●	
025	Cuchara taza Cucchiaino brodo/panna	●	●	●	●	●	●	●	●	●	●	●
091	Cuchillo para mantequilla Coltello da burro	●	●	●	●	●	●	●	●	●	●	●
092	Cuchillo para queso Coltello da formaggio	●	●	●	●	●	●	●	●	●	●	●
045	Cuchillo servir pescado Coltello pesce	●	●	●	●	●	●	●	●	●	●	●
046	Tenedor servir pescado Forchetta servire pesce	●	●	●	●	●	●	●	●	●	●	●
031	Tenedor carne, grande Forchetta carne, grande	●	●	●	●	●	●	●	●	●	●	●
032	ídem, pequeño Forchetta carne, piccola											
050	Pala bizcocho Pala dolci			●	●	●	●	●	●			●
038	Tenedor verdura Forchetta legumi	●	●	●	●	●	●	●	●	●	●	●
039	Cuchara servir Cucchiaino servire	●	●	●	●	●	●	●	●	●	●	●
044	Cuchara servir Cucchiaino servire, gr.	●	●	●	●	●	●	●	●	●	●	●
014	Cuchara infantil Cucchiaino per bambini			●	●	●	●	●	●		s. Art. 026	●
015	Tenedor infantil Forchetta per bambini			●	●	●	●	●	●		s. Art. 026	●
016	Cuchillo infantil Coltello per bambini			●	●	●	s. Art. 068	s. Art. 068	●		s. Art. 068	●
086	Espumadera Schiumarola											
025	Cuchara nata Cucchiaino brodo/panna	●	●	●	●	●	●	●	●	●	●	●
061	Cuchara nata, curvada Cucchiaino panna, piegato				●	●						
040	Cuchara ensalada, grande Cucchiaino serv. insalata, gr.	●	●	●	●	●	●	●	●	●	●	●
041	Tenedor ensalada, grande Forchetta servire insalata, grande	●	●	●	●	●	●	●	●	●	●	●
042	Cuchara ensalada pequeña Cucchiaino servire insalata	●	●	●	●	●	●	●	●	●	●	●
043	Tenedor ensalada pequeño Forchetta servire insalata, piccola	●	●	●	●	●	●	●	●	●	●	●
035	Cuchara salsa Cucchiaino salsa	●	●	●	●	●	●	●	●	●	●	●
019	Servilletero Portatovagliolo	●	●	●	●	●	●	●	●	●	●	●
047	Pala para espárragos Paletta per asparagi	●	●	●	●	●	●	●	●	●	●	●
087	Pinzas para espárragos Pinza per asparagi											
036	Cazo sopa Mestolo	●	●	●	●	●	●	●	●	●	●	●
052	Pala tarta Pala torta	●	●	●	●	●	●	●	●	●	●	●
054	Cuchillo tarta Coltello torta	●	●	●	●	●	●	●	●	●	●	●
048	Cuchillo trinchar Coltello trinciante	●	●	●	●	●	●	●	●	●	●	●
049	Tenedor trinchar Forchetta trinciante	●	●	●	●	●	●	●	●	●	●	●
148	Cuchillo trinchar Coltello trinciante – Frozen Black									●	●	
149	Tenedor trinchar Forchetta trinciante – Frozen Black									●	●	
064	Cucharilla azúcar Cucchiaino zucchero	●	●	●	●	●	●	●	●	●	●	●
065	Pinzas azúcar Pinza zucchero	●	●	●	●	●	●	●	●	●	●	●











064	038	040	055	010	070	057	071	056	045	060	072	069	061		Ref. Art. no.
Riva	Rosenmuster*	Alt-Kopenhagen	Viva	Ostfresen*	Hermitage*	Classic-Faden*	Eclipse	Arcade*	Alt-Faden	Art Deco*	I2	Sphinx	Glo*		
2	2	2	2	2	2	3	3	3	3	3	3	3	3		
2	3	3	3	3	3	2	2	3	3	3	3	3	3		
●	●	●	●	●	●	●	●	●	●	●	●	●	●	Cuchara mesa Cucchiaino tavola	004
●	●	●	●	●	●	●	●	●	●	●	●	●	●	Tenedor mesa Forchetta tavola	005
●	●	●	●	●	●	●	●	●	●	●	●	●	●	Cuchillo mesa Coltello tavola	006
●				●						●				Cuchillo mesa Coltello tavola – Frozen Black	106
				●						●				Cuchara banquete Cucchiaino tavola, grande	001
				●						●				Tenedor banquete Forchetta tavola, grande	002
				●						●				Cuchillo banquete Coltello tavola, grande	003
●	●	●	●	●	●	●	●	●	●	●	●	●	●	Cuchara postre/entremés Cucchiaino frutta	007
●	●	●	●	●	●	●	●	●	●	●	●	●	●	Tenedor postre/entremés Forchetta frutta	008
●	●	●	●	●	●	●	●	●	●	●	●	●	●	Cuchillo postre/entremés Coltello frutta	009
	●	●	●	●	●	●	●	●	●	●	●	●	●	Cuchara café, grande Cucchiaino tè e colazione	020
●	●	●	●	●	●	●	●	●	●	●	●	●	●	Cuchara café Cucchiaino caffè-tè	021
				●										Cuchara té Cucchiaino tè	022
●	●	●	●	●	●	●	●	●	●	●	●	●	●	Cuchara moca Cucchiaino moca/espresso	023
●	●	●	●	●	●	●	●	●	●	●	●	●	●	Tenedor tarta Forchetta dolci	027
●	●	●	●	●	●	●	●	●	●	●	●	●	●	Tenedor ostras Forchetta ostriche	068
	●	●		●	●	●		●	●	●			●	Cuchillo de mantequilla Coltello burro	028
s. Art. 068	●	●		●	●	●	s. Art. 068	●	●	●		s. Art. 068	●	Cuchara helado Cucchiaino gelato	083
s. Art. 064	●	●	s. Art. 064	●	●	●	●	●	●	●	s. Art. 064	s. Art. 020	●	Cuchillo pescado Coltello pesce	026
●	●	●	●	●	●	●	●	●	●	●	●	●	●	Tenedor pescado Forchetta pesce	010
●	●	●	●	●	●	●	●	●	●	●	●	●	●	Cuchara gourmet Cucchiaino salsa individual	011
●	●	●	●	●	●	●	●	●	●	●	●	●	●	Tenedor de marisco Forchetta aragosta	097
●	●	●	●	●	●	●	●	●	●	●	●	●	●	Cuchillo fruta Coltello dolci	029
●	●	●	●	●	●	●	●	●	●	●	●	●	●	Cuchillo steak Coltello bistecca	084
●	●	●	●	●	●	●	●	●	●	●	●	●	●	Cuchillo steak Coltello bistecca – Frozen Black	184
●	●	●	●	●	●	●	●	●	●	●	●	●	●	Cuchara taza Cucchiaino brodo/panna	025
●	●	●	●	●	●	●	●	●	●	●	●	●	●	Cuchillo para mantequilla Coltello da burro	091
●	●	●	●	●	●	●	●	●	●	●	●	●	●	Cuchillo para queso Coltello da formaggio	092
●	●	●	●	●	●	●	●	●	●	●	●	●	●	Cuchillo servir pescado Coltello pesce	045
●	●	●	●	●	●	●	●	●	●	●	●	●	●	Tenedor servir pescado Forchetta servire pesce	046
●	●	●	●	●	●	●	●	●	●	●	●	●	●	Tenedor carne, grande Forchetta carne, grande	031
	●	●	●	●	●	●	●	●	●	●	●	●	●	ídem, pequeño Forchetta carne, pequeña	032
	●	●	●	●	●	●	●	●	●	●	●	●	●	Pala bizcocho Pala dolci	050
●	●	●	●	●	●	●	●	●	●	●	●	●	●	Tenedor verdura Forchetta legumi	038
●	●	●	●	●	●	●	●	●	●	●	●	●	●	Cuchara servir Cucchiaino servire	039
●	●	●	●	●	●	●	●	●	●	●	●	●	●	Cuchara servir Cucchiaino servire, gr.	044
	●	●	●	●	●	●		●				s. Art. 025		Cuchara infantil Cucchiaino per bambini	014
	●	●	●	●	●	●		●				●		Tenedor infantil Forchetta per bambini	015
	●	●	●	●	●	●	s. Art. 068	●				s. Art. 068		Cuchillo infantil Coltello per bambini	016
●	●	●	●	●	●	●	●	●	●	●	●	●	●	Espumadera Schiumarola	086
●	●	●	●	●	●	●	●	●	●	●	●	●	●	Cuchara nata Cucchiaino brodo/panna	025
●	●	●	●	●	●	●	●	●	●	●	●	●	●	Cuchara nata, curvada Cucchiaino panna, piegato	061
●	●	●	●	●	●	●	●	●	●	●	●	●	●	Cuchara ensalada, grande Cucchiaino serv. insalata, gr.	040
●	●	●	●	●	●	●	●	●	●	●	●	●	●	Tenedor ensalada, grande Forchetta servire insalata, grande	041
	●	●	●	●	●	●	●	●	●	●	●	●	●	Cuchara ensalada pequeña Cucchiaino servire insalata	042
	●	●	●	●	●	●	●	●	●	●	●	●	●	Tenedor ensalada pequeño Forchetta servire insalata, pequeña	043
●	●	●	●	●	●	●	●	●	●	●	●	●	●	Cuchara salsa Cucchiaino salsa	035
●	●	●	●	●	●	●	●	●	●	●	●	●	●	Servilletero Portatovagliolo	019
	●	●	●	●	●	●	●	●	●	●	●	●	●	Pala para espárragos Paleta per asparagi	047
●	●	●	●	●	●	●	●	●	●	●	●	●	●	Pinzas para espárragos Pinza per asparagi	087
●	●	●	●	●	●	●	●	●	●	●	●	●	●	Cazo sopa Mestolo	036
●	●	●	●	●	●	●	●	●	●	●	●	●	●	Pala tarta Pala torta	052
●	●	●	●	●	●	●	●	●	●	●	●	●	●	Cuchillo tarta Coltello torta	054
●	●	●	●	●	●	●	●	●	●	●	●	●	●	Cuchillo trinchar Coltello trinciante	048
●	●	●	●	●	●	●	●	●	●	●	●	●	●	Tenedor trinchar Forchetta trinciante	049
●	●	●	●	●	●	●	●	●	●	●	●	●	●	Cuchillo trinchar Coltello trinciante – Frozen Black	148
●	●	●	●	●	●	●	●	●	●	●	●	●	●	Tenedor trinchar Forchetta trinciante – Frozen Black	149
●	●	●	●	●	●	●	●	●	●	●	●	●	●	Cucharilla azúcar Cucchiaino zucchero	064
●	●	●	●	●	●	●	●	●	●	●	●	●	●	Pinzas azúcar Pinza zucchero	065



Gilding* Dorure* Baño* Doratura*	Partial Gilding Dorure de décor Con adorno bañado en oro Con i particolari oro	Complete Gilding Dorure totale Baño completo Doratura completa All cutlery items are also available with full gold plating on request. Please feel free to contact us at: Tous les couverts sont également disponibles en version entièrement plaquée or sur demande. N'hésitez pas à nous contacter à l'adresse suivante : Todas las piezas de cubertería están disponibles, previa solicitud, con baño completo de oro. No dude en ponerse en contacto con nosotros en: Tutti i pezzi di posate sono disponibili, su richiesta, anche con placcatura in oro. Non esitate a contattarci all'indirizzo: gold@robbeberking.com
		

Art.-No. No. d'article Ref. Art. no.	Available for Disponible pour Disponibile para Disponibile per: 👑 925 Sterling Silver/ 🗍 150 massive silver plated
---------------------------------------------	-----------------------------------------------------------------------------------------------------------------------------

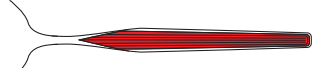
004	Menu spoon Cuiller à menu Cuchara mesa Cucchiaino tavola
005	Menu fork Fourchette à menu Tenedor mesa Forchetta tavola
006	Menu knife Couteau à menu Cuchillo mesa Coltello tavola
106	Menu knife Couteau à menu Cuchillo mesa Coltello tavola – Frozen Black
001	Table spoon Cuiller de table Cuchara banquette Cucchiaino tavola, grande
002	Table fork Fourchette de table Tenedor banquette Forchetta tavola, grande
003	Table knife Couteau de table Cuchillo banquette Coltello tavola, grande
007	Dessert spoon Cuiller à dessert Cuchara postre/entremés Cucchiaino frutta
008	Dessert fork Fourchette à dessert Tenedor postre/entremés Forchetta frutta
009	Dessert knife Couteau à dessert Cuchillo postre/entremés Coltello frutta
020	Coffee spoon, large Cuiller à café, grande Cuchara café, grande Cucchiaino tè e colazione
021	Coffee spoon Cuiller à café Cuchara café Cucchiaino caffè-tè
022	Tea spoon III Cuiller à thé Cuchara té Cucchiaino tè
023	Mocha-/espresso spoon Cuiller à moka Cuchara moca Cucchiaino moca/espresso
027	Cake fork, large Fourchette à gâteaux, grande Tenedor tarta Forchetta dolci
068	Cake knife Couteau à gâteaux Cuchillo tarta Coltello dolci
028	Oyster fork Fourchette à huîtres Tenedor ostras Forchetta ostriche
083	Butter spreader Tartineur Cuchillo de mantequilla Coltello burro
026	Ice-cream spoon Cuiller à glace Cuchara helado Cucchiaino gelato
010	Fish knife Couteau à poisson Cuchillo pescado Coltello pesce
011	Fish fork Fourchette à poisson Tenedor pescado Forchetta pesce
097	Gourmet spoon Cuiller gourmet Cuchara gourmet Cucchiaino salsa individuale
029	Lobster fork Fourchette à homard Tenedor de marisco Forchetta aragosta
084	Steak knife Couteau à steak Cuchillo steak Coltello bistecca
184	Steak knife Couteau à steak Cuchillo steak Coltello bistecca – Frozen Black
025	Broth spoon Cuiller à consommé Cuchara taza Cucchiaino brodo/panna
091	Butter knife, hollow handle Couteau à beurre, lame inox Cuchillo para mantequilla Coltello da burro
092	Cheese knife, hollow handle Couteau à fromage, lame inox Cuchillo para queso Coltello da formaggio
045	Fish serving knife Couteau à servir le poisson Cuchillo servir pescado Coltello pesce
046	Fish serving fork Fourchette à servir le poisson Tenedor servir pescado Forchetta servire pesce
031	Meat fork, large Fourchette à viande, grande Tenedor carne, grande Forchetta carne, grande
032	Meat fork, small Fourchette à viande, petite Ídem, pequeño Forchetta carne, piccola
050	Pastry server Pelle à gâteaux Pala bizcocho Pala dolci
038	Serving fork Fourchette à servir Tenedor para servir Forchetta per servire
039	Serving spoon Cuiller à servir Cuchara servir Cucchiaino servire
044	Serving spoon, large Cuiller à servir, grande Cuchara servir Cucchiaino servire, gr.
014	Children's spoon Cuiller pour enfants Cuchara infantil Cucchiaino per bambini
015	Children's fork Fourchette pour enfants Tenedor infantil Forchetta per bambini
016	Children's knife Couteau pour enfants Cuchillo infantil Coltello per bambini
086	Pierced Spoon Cuillère percée Espumadera Schiumarola
025	Cream spoon Cuiller à crème Cuchara nata Cucchiaino brodo/panna
061	Cream spoon, bent Cuiller à crème, cintrée Cuchara nata, curvada Cucchiaino panna, piegato
040	Salad spoon, large Cuiller à servir la salade, grande Cuchara ensalada, grande Cucchiaino serv. insalata, gr.
041	Salad fork, large Fourchette à servir la salade, grande Tenedor ensalada, grande Forchetta servire insalata, grande
042	Salad spoon, small Cuiller à servir la salade, petit Cuchara ensalada pequeña Cucchiaino servire insalata
043	Salad fork, small Fourchette à servir la salade, petit Tenedor ensalada pequeño Forchetta servire insalata, piccola
035	Sauce ladle Cuiller à sauce Cuchara salsa Cucchiaino salsa
019	Table napkin ring Rond de serviette Servilletero Portatovagliolo
047	Asparagus server Pelle à asperges Pala para espárragos Paletta per asparagi
036	Soup ladle Louche Cazo sopa Mestolo
052	Tart server Pelle à tarte Pala tarta Pala torta
054	Tart knife Couteau à tarte Cuchillo tarta Coltello torta
048	Carving knife Couteau à découper Cuchillo trinchar Coltello trinciante
049	Carving fork Fourchette à découper Tenedor trinchar Forchetta trinciante
148	Carving knife Couteau à découper Cuchillo trinchar Coltello trinciante – Frozen Black
149	Carving fork Fourchette à découper Tenedor trinchar Forchetta trinciante – Frozen Black
064	Sugar spoon Cuiller à sucre Cucharilla azúcar Cucchiaino zucchero
065	Sugar tongs Pince à sucre Pinzas azúcar Pinza zucchero

Partial Gilding Dorure de décor Con adorno bañado en oro Con i particolari oro	
Alt-Chippendale	
Arcade	
Art Deco	
Avenue	
Belvedere	
Classic-Faden	
Französisch-Perl	
Gio	
Hermitage	
Metropolitan	
Ostfriesen	
Rosenmuster	



12. Alta, Riva

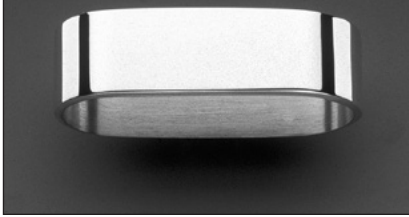

👑 925 07203019, 05003019, 06403019
🏠 150 07202019, 05002019, 06402019

Alt-Chippendale, Navette

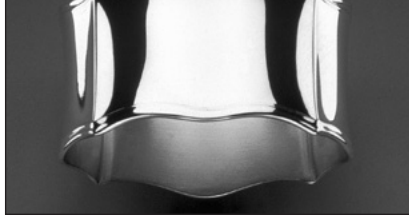

👑 925 05303019, 04803019
🏠 150 05302019, 04802019

Alt-Faden

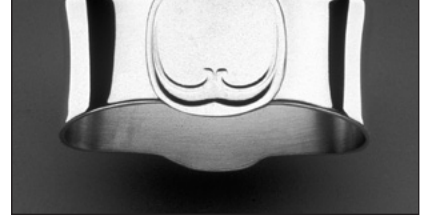

👑 925 04503019
🏠 150 04502019

Alt-Kopenhagen



👑 925 04003019
🏠 150 04002019

Alt-Spaten, Spaten, Dante, Eclipse

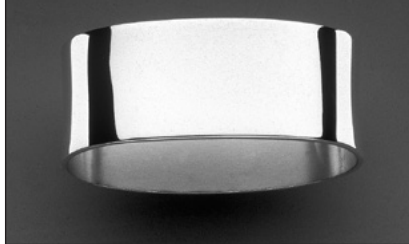

👑 925 01903019, 02003019, 06203019, 07103019
🏠 150 01902019, 02002019, 06202019, 07102019

Arcade



👑 925 05603019
🏠 150 05602019

Art Deco

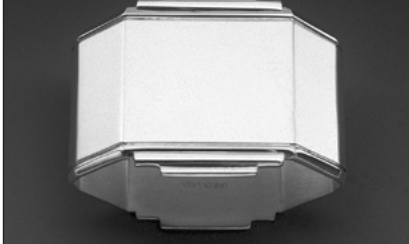

👑 925 06003019
🏠 150 06002019

Avenue, Metropolitan

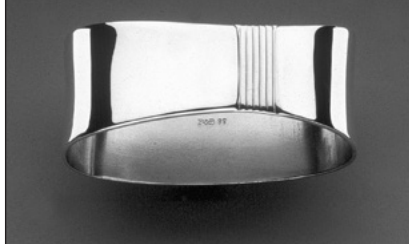

👑 925 04403019, 07303019
🏠 150 04402019, 07302019

Classic-Faden



👑 925 05703019
🏠 150 05702019

Französisch-Perl



👑 925 04603019
🏠 150 04602019

Gio



👑 925 06103019
🏠 150 06102019

Hermitage, Martelé

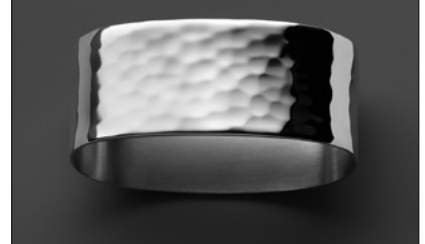

👑 925 07003019, 06303019
🏠 150 07002019, 06302019

Ostfriesen



👑 925 01003019
🏠 150 01002019

Rosenmuster



👑 925 03803019
🏠 150 03802019

Sphinx



👑 925 06903019
🏠 150 06902019

Shape and size of individual pieces
La forme et la taille des pièces individuelles

Forma y tamaño de cada pieza
Forma e misura dei singoli pezzi



001 Table spoon, 21,0 cm
Cuiller de table | Cuchara banquete
Cucchiaio tavola, grande
004 Menu spoon, 20,2 cm
Cuiller à menu | Cuchara mesa
Cucchiaio tavola

003 Table knife, 24,5 cm
Couteau de table | Cuchillo banquete
Coltello tavola, grande
006 Menu knife, 23,5 cm
Couteau à menu | Cuchillo mesa
Coltello tavola

008 Dessert fork, 18,2 cm
Fourchette à dessert
Tenedor postre/entremés
Forchetta frutta

020 Coffee spoon large, 14,8 cm
Cuiller à café, grande
Cuchara café, grande
Cucchiaio tè e colazione

023 Mocha spoon, 10,3 cm
Cuiller à moka
Cuchara moca
Cucchiaio moca/espresso

002 Table fork, 20,5cm
Fourchette de table | Tenedor banquete
Forchetta tavola, grande
005 Menu fork, 19,8 cm
Fourchette à menu | Tenedor mesa
Forchetta tavola

007 Dessert spoon, 18,5 cm
Cuiller à dessert
Cuchara postre/entremés
Cucchiaio frutta

009 Dessert knife, 21,4 cm
Couteau à dessert
Cuchillo postre/entremés
Coltello frutta

021 Coffee spoon, 13,3 cm
Cuiller à café
Cuchara café
Cucchiaio caffè-tè



029 Lobster fork, 18,5 cm
Fourchette à homard
Tenedor de marisco
Forchetta aragosta

025 Broth spoon, 15,1 cm
Cuiller à consommé
Cuchara taza
Cucchiaio brodo

092 Cheese knife, hollow handle, 20,5 cm
Couteau à fromage, lame inox
Cuchillo queso con hoja de acero
Coltello formaggio

046 Fish serving fork, 21,6 cm
Fourchette à servir le poisson
Tenedor servir pescado
Forchetta servire pesce

084 Steak knife, 23,0 cm
Couteau à steak
Cuchillo steak
Coltello bistecca

091 Butter knife, hollow handle, 20,0 cm
Couteau à beurre, lame inox
Cuchillo mantequilla con hoja de acero
Coltello burro

045 Fish serving knife, 29,3 cm
Couteau à servir le poisson
Cuchillo servir pescado
Coltello pesce



041 Salad fork, large, 20,5 cm
Fourchette à servir la salade, grande
Tenedor ensalada, grande
Forchetta servire insalata, grande

043 Salad fork, small, 19,0 cm
Fourchette à servir la salade, petite
Tenedor ensalada pequeño
Forchetta servire insalata, piccola

019 Table napkin ring, 5,4 cm
Lien de serviette
Servilletero
Portatovagliolo

040 Salad spoon, large, 20,5 cm
Cuiller à servir la salade, grande
Cuchara ensalada, grande
Cucchiaio serv. insalata, gr.

042 Salad spoon, small, 19,0 cm
Cuiller à servir la salade, petite
Cuchara ensalada pequeña
Cucchiaio servire insalata

035 Sauce ladle, 17,5 cm
Cuiller à sauce
Cuchara salsa
Cucchiaio salsa

047 Asparagus server/tongs, 21,5 cm
Pelle/pince à asperges
Pala/pinza espárragos
Pala/pinze asparagi

The shape of each piece is individually styled to match the respective cutlery pattern.

The individual pieces of the pattern Alt-Spaten illustrated below as well as the measures indicated do therefore only serve as a clue for other patterns.

La forme et la taille des pièces individuelles varient d'un modèle à l'autre. Les pièces individuelles du modèle Alt-Spaten illustrées ici et les mesures approximatives indiquées ici ne peuvent donc servir que d'indication pour d'autres modèles.

La forma y la longitud de cada pieza varía en función del modelo.

Las piezas aquí reproducidas del modelo Alt-Spaten y las medidas aproximadas que se indican sólo pretenden ser orientativos.

Forma e lunghezza dei singoli pezzi variano da modello a modello.

Le posate esposte qui sono del modello Alt-Spaten e le misure all'incirca sono un tipo di indicazione.



027 Cake fork, 15,3 cm
Fourchette à gâteaux
Tenedor tarta
Forchetta dolci



028 Oyster fork, 14,7 cm
Fourchette à huîtres
Tenedor ostras
Forchetta ostricera



026 Ice-cream spoon, 14,8 cm
Cuiller à glace
Cuchara helado
Cucchiaino gelato



011 Fish fork, 17,6 cm
Fourchette à poisson
Tenedor pescado
Visvork
Forchetta pesce



068 Cake knife/fruit knife, 16,4 cm
Couteau à gâteaux
Cuchillo tarta
Coltello dolci

083 Butter spreader, 18,8 cm
Tartineur
Cuchillo de mantequilla
Coltello burro

010 Fish knife, 21,0 cm
Couteau à poisson
Cuchillo pescado
Coltello pesce

097 Gourmet spoon, 18,5 cm
Cuiller gourmet
Cuchara gourmet
Cucchiaino salsa individuale



031 Meat fork, large, 18,2 cm
Fourchette à viande, grande
Tenedor carne, grande
Forchetta carne, grande

050 Pastry server, 16,7 cm
Pelle à gâteaux
Pala bizcocho
Pala dolci

039 Serving spoon, 23,0 cm
Cuiller à servir
Cuchara servir
Cucchiaino servire

025 Cream spoon, 15,1 cm
Cuiller à crème
Cuchara nata
Cucchiaino panna

032 Meat fork, small, 15,1 cm
Fourchette à viande, petite
Tenedor carne, pequeño
Forchetta carne, piccola

038 Serving fork, 23,0 cm
Fourchette à servir
Tenedor para servir
Forchetta per servire

044 Serving spoon, large, 27,0 cm
Cuiller à servir, grande
Cuchara servir
Cucchiaino servire, gr.



036 Soup ladle, 27,5 cm
Louche
Cazo sopa
Mestolo

054 Tart knife, 26,0 cm
Couteau à tarte
Cuchillo tarta
Coltello torta

049 Carving fork, 22,8 cm
Fourchette à découper
Tenedor trinchar
Forchetta trinciante

065 Sugar tongs, 9,4 cm
Pince à sucre
Pinzas azúcar
Pinza zucchero

052 Tart server, 23,5 cm
Pelle à tarte
Pala tarta
Pala torta

048 Carving knife, 25,4 cm
Couteau à découper
Cuchillo trinchar
Coltello trinciante

064 Sugar spoon, 12,9 cm
Cuiller à sucre
Cucharilla azúcar
Cucchiaino zucchero

Length of items (cm)
 Longueur des articles individuels (cm)
 Longitud de los artículos (cm)
 Lunghezza degli articoli (cm)



Art. No. | Art. Nr. | Ref. | Art. no.

		072	050	053	045
004	Menu spoon Cuiller à menu Cuchara mesa Cucchiaino tavola	21,4	20,3	20,4	20,4
005	Menu fork Fourchette à menu Tenedor mesa Forchetta tavola	21	19,8	20	19,6
006	Menu knife Couteau à menu Cuchillo mesa Coltello tavola	23,7	21,6	23,1	22,9
106	Menu knife Couteau à menu Cuchillo mesa Coltello tavola – Frozen Black				
001	Table spoon Cuiller de table Cuchara banquete Cucchiaino tavola, grande		21,3		
002	Table fork Fourchette de table Tenedor banquete Forchetta tavola, grande		20,6		
003	Table knife Couteau de table Cuchillo banquete Coltello tavola, grande		23,6		
007	Dessert spoon Cuiller à dessert Cuchara postre/entremés Cucchiaino frutta	19,6	18,3	18,4	19
008	Dessert fork Fourchette à dessert Tenedor postre/entremés Forchetta frutta	19,1	18	18	18,5
009	Dessert knife Couteau à dessert Cuchillo postre/entremés Coltello frutta	21,8	19,8	21,3	21,3
020	Coffee spoon, large Cuiller à café, grand Cuchara café, grande Cucchiaino tè e colazione	15,1	15	14,7	14,8
021	Coffee spoon Cuiller à café Cuchara café Cucchiaino caffè-tè	13,8	13,4	12,9	13
022	Tea spoon III Cuiller à thé Cuchara té Cucchiaino tè				
023	Mocha-/espresso spoon Cuiller à moka Cuchara moca Cucchiaino moca/espresso	11,5	11	10,7	10,7
027	Cake fork, large Fourchette à gâteaux, grande Tenedor tarta Forchetta dolci	16	15	15	14,7
068	Cake knife Couteau à gâteaux Cuchillo tarta Coltello dolci	17,1	16,5	17,5	16,8
028	Oyster fork Fourchette à huîtres Tenedor ostras Forchetta ostriche		14,8	14	14,3
083	Butter spreader Tartineur Cuchillo de mantequilla Coltello burro		18,4	18,4	18,4
026	Ice-cream spoon Cuiller à glace Cuchara helado Cucchiaino gelato	14,8	14,8	14,5	14,4
010	Fish knife Couteau à poisson Cuchillo pescado Coltello pesce	23	20,5	20,5	21,5
011	Fish fork Fourchette à poisson Tenedor pescado Forchetta pesce	19,1	18,2	17,6	18,1
097	Gourmet spoon Cuiller gourmet Cuchara gourmet Cucchiaino salsa individuale	19,6	18,2	18,2	18,2
029	Lobster fork Fourchette à homard Tenedor de marisco Forchetta aragosta		21,2	18,5	18,5
084	Steak knife Couteau à steak Cuchillo steak Steakmes Coltello bistecca	24	22,2	22,5	22
184	Steak knife Frozen Black Couteau à steak Frozen Black Cuchillo steak Coltello bistecca (Frozen Black)				
025	Broth spoon Cuiller à consommé Cuchara taza Cucchiaino brodo/panna	15,6	15,3	15,1	15,2
091	Butter knife Couteau à beurre Cuchillo mantequilla Coltello burro	20,7	19,9	20,1	19,9
092	Cheese knife Couteau à fromage Cuchillo queso Coltello formaggio	21,8	19,8	20,4	20
045	Fish serving knife Couteau à servir le poisson Cuchillo servir pescado Coltello pesce	28,2	28,5	28,9	28,7
046	Fish serving fork Fourchette à servir le poisson Tenedor servir pescado Forchetta servire pesce	26,3	21,4	21,4	21,6
031	Meat fork, large Fourchette à viande, grande Tenedor carne, grande Forchetta carne, grande	19	18,1	18	17,9
032	Meat fork, small dito, petite idem, pequeño Forchetta carne, piccola		14,8	15	14,8
050	Pastry server Pelle à gâteaux Pala bizcocho Pala dolci		19	16,5	16,6
038	Serving fork Fourchette à servir Tenedor para servir Forchetta per servire	23,7	24,5	21,4	22,4
039	Serving spoon Cuiller à servir Cuchara servir Cucchiaino servire	24,4	24,6	22	22,6
044	Serving spoon, large Cuiller à servir, grand Cuchara servir Cucchiaino servire, gr.	26,5	28	26	27
014	Children's spoon Cuiller pour enfants Cuchara infantil Cucchiaino per bambini		15,5	15,2	18,4
015	Children's fork Fourchette pour enfants Tenedor infantil Forchetta per bambini		15,4	14,6	17,3
016	Children's knife Couteau pour enfants Cuchillo infantil Coltello per bambini		17,8	17,5	20
086	Pierced spoon Cuillère percée Espumadera Schiumarola				
025	Cream spoon Cuiller à crème Cuchara nata Cucchiaino brodo/panna	15,6	15,3	15,1	15,2
061	Cream spoon, bent Cuiller à crème, cintrée Cuchara nata, curvada Cucchiaino panna, piegato				
040	Salad spoon, large Cuiller à servir la salade, grand Cuchara ensalada, grande Cucchiaino serv. insalata, gr.	29	25,5	25	20,5
041	Salad fork, large Fourchette à servir la salade, grand Tenedor ensalada, grande Forchetta servire insalata, grande	29,2	25	24,5	20
042	Salad spoon, small Cuiller à servir la salade, petit Cuchara ensalada pequeña Cucchiaino servire insalata		20	18,5	18,5
043	Salad fork, small Fourchette à servir la salade, petit Tenedor ensalada pequeño Forchetta servire insalata, piccola		21	18,2	18,4
035	Sauce ladle Cuiller à sauce Cuchara salsa Cucchiaino salsa	19,1	18,6	17	18,5
019	Table napkin ring Rond de serviette Servilitero Portatovagliolo	5,8	5,8	5,3	5,4
047	Asparagus server Pelle à asperges Pala para espárragos Paletta per asparagi		21,6	21,8	21,2
087	Asparagus tongs Pince à asperges Pinzas para espárragos Pinza per asparagi				
036	Soup ladle Louche Cazo sopa Mestolo	28,5	29	28,7	27,6
052	Tart server Pelle à tarte Pala tarta Pala torta	24,6	23,5	23,2	23,4
054	Tart knife Couteau à tarte Cuchillo tarta Coltello torta	28	27,5	25,1	25,6
048	Carving knife Couteau à découper Cuchillo trinchar Coltello trinciante	26,7	30,9	31,2	24,7
148	Carving knife Couteau à découper Cuchillo trinchar Coltello trinciante (Frozen Black)				
049	Carving fork Fourchette à découper Tenedor trinchar Forchetta trinciante	27	27	26,5	22
149	Carving fork Fourchette à découper Tenedor trinchar Forchetta trinciante (Frozen Black)				
064	Sugar spoon Cuiller à sucre Cucharilla azúcar Cucchiaino zucchero	14,6	14	12,6	13,4
065	Sugar tongs Pince à sucre Pinzas azúcar Pinza zucchero	9,2	13	9,5	9,4

040	019	056	060	044	068	057	062	071	046	061	070	063	073	048	010	064	038	020	069	055
Alt-Kopenhagen	Alt-Spaten	Arcade	Art Deco	Avenue	Belvedere	Classic-Faden	Dante	Eclipse	Französisch-Perf	Glo	Hermitage	Martelé	Metropolitan	Navette	Ostfriesen	Riva	Rosenmuster	Spaten	Sphinx	Viva
20,1	20	20,5	20,2	20,1	20,4	20,5	20,4	20,4	20,2	20,4	21	20,4	20,2	20,2	19,7	21,9	20,3	20,2	21,2	22
19,8	20,4	20	19,8	19,5	20,2	19,9	20,4	20	19,5	20	20,5	20	20	19,8	19,5	21,2	20,2	19,6	21,1	20
21,9	23,2	24	22,2	21,7	24	23,4	23,6	23,9	22,4	22,2	23,7	23,9	22,5	21,8	22	23,9	21	22,4	24,2	23
					24							23,9				23,9				
			20,9	21,1										21,1	21,5			21,9		
			20,5	20,6										20,6	20,9			21,5		
			23,2	24,2										23,5	24,3			23,5		
18,5	18,5	18,5	18,8	18,5	18,5	19	18,4	18,2	18,7	18,8	18,4	18,2	18,6	18,5	18	20	18,5	18,5	19,8	18,5
17,5	18	18	18,5	18	18	18,5	18,5	18	18,5	18,5	17,2	18	17,9	18	17,5	20	18,5	18	19,5	18
19,7	21,5	21,5	21,6	20,1	21,7	21,3	21,7	21,4	21,1	20,9	21,2	21,4	20,5	20,2	21	21,8	20,4	20,6	22,5	21
14,9	14,8	14,7	14,6	14,7	14,8	14,8	14,8	15	14,9	14,5	14,5	15	15	14,6	14,4		15	14,9	15,4	14,7
13	13,2	12,9	13,5	13	12,8	13,1	13	13	13,1	12,6	13,1	13	13,2	12,8	12,8	14,2	13	13,2	14,4	13,3
															12,1					
10,7	10,2	10,9	11	10,6	11	10,7	10,9	10,9	10,7	11	11	10,9	10,6	10,7	10,8	12,5	10,8	10,2	13	11
14,8	15,1	14,9	15	14,9	14,5	15,1	14,9	14,8	15	14,6	14,6	14,8	15,1	15	15	15,4	15,3	15	16,1	14,7
16,7	17	16,7	16,8	16,5	16,8	16,8	16,4	16,3	16,7	17	16,6	16,3	17,5	16,8	16,8	18	16,8	17	19,8	17
14,2	14,5	13,9	14,5	14	13,9	14,2	14		14,3	14,5	14,2	14	14,7	14	14,3		14,6	14,5		
18,7	18,5	18,7	18,5	18,3	16,8	18,3	18,5	16,3	18,2		17	16,3	17,5	18,1	18,2	18	19,1	19	19,8	
14,6	14,7	14,5	14,5	14,4	14,8	14,8		14,6	14,8	14,5	14,5	14,6	15	14,4	14,3	16	14,8	14,8	15,3	13,8
21,5	20,5	21	22	21,5	21,5	22	21,5	21,5	22	21	21,7	21,5	21,2	20,5	21	23	21	22	23	20,5
17,1	17,9	17,5	18	17,1	17,5	18,3	17,8	18,1	18,2	18,6	17,9	18,1	17,9	17,6	17,4	19,5	18,2	17,9	21,4	17,9
18,5	18,2	18,1	18,6	18,2	18,2	18,2	18,3	18,1	18,3	18,5	18,5	18,1	18,3	18,3	18,1	20,2	18,7	18,2	21,9	18,4
17,9	18,5	18,4	18,1	18,2		18,3			18,3		18		18,3	18,7	18,4	22,5	18,3	18,5	21,5	
22,5	22,2	22,1	22	22	22,3	22,3	22,5	22,5	21,7	22,5	22,8	22,5	24,3	22	22	22,3	22,7	22,7	22,8	22,6
		22,2			22,3							22,5				22,3				
15,1	15,3	17,1	15	14,8	15,2	15,2	15,1	15,1	15	15,3	15	15,1	15,5	15	15	16	15,4	15,6	16	15,2
19,3	20,5	19,3	20,2	20	20,3	19,4	20,2	19,8	19,2	20,2	21	19,8	21	19	18,9	20,2	20,5	19,3	19,5	20,2
20,5	20	20,5	20,4	20	24	20,3	20,5	20,3	19,8	20,5	22	20,3	22,2	20	19,5	20,5	21,5	20,5	20	20,2
28,9	29,3	29	29,1	28,3	27,5	28,8	27,8	27,9	28,9	28,7	30	27,9	28,3	29	30,2	29,2	29,5	29,1	28,2	28,6
21,5	21,5	21,4	21,6	21,5	21,3	21,4	23,2	22,9	21,3	21,9	23	22,9	21,3	21,5	22,4	26,3	21,5	21,8	25,7	21,8
17,6	18,1	18	18,5	17,8	18,2	17,8	17,7	18,6	17,9	18,5	18,2	18,6	17,9	18	17,6	18,9	18	18,3	18,9	17,2
14,9	15,1	15	15,1	15,1		14,9			14,8	15	15			14,8	15,1		15,1	14,9		15
16,6	16,8	16,6	17	16,6		16,6			16,2	17,9	16,3			16,4	20		16,7	26		18,7
22,6	22,6	21,5	22,8	22,6	21,5	23	22	22,3	23	23,5	22	22,3	20,7	22,5	21,1	26	22,6	22,8	24,6	23,7
22,6	23	22,1	23,1	23	22,1	23,1	23	23,1	23	24,1	22,2	23,1		22,6	22	26,7	22,7	22,7	24,8	24
26	27,1	26,1	25,9	27	26,2	26,9	26,4	26,3	26,9	27,9	26,3	26,3	27,3	26,5	26,1	26,3	26,8	27,1	27,2	27,7
17,3	15,2			17,5		15,1			17,5			14,6		17,6	16,7		17,2	17,5	16	
16,7	14,5			17,2		14,9			17			14,8		17,3	16,2		16,8	17	15,9	
18,7	17			19,5		16,8			19,6			16,3		18,5	18,6		18,3	19	19,8	
								26,3			26,3									
15,1	15,3	17,1	15	14,8	15,2	15,2	15,1	15,1	15	15,3	15	15,1	15,5	15	15	16	15,4	15,6	16	15,2
											11,5			10	12		12	11		
19,5	20	24,5	22,9	20	24,5	20,3	23	23	20	19,5	21,9	23	20	24,5	21,5	30	20	19,5	30	20,5
19,5	20	24,5	22,9	20	24,5		23	23	20	20	21,9	23	19,9	24,5	21,5	30	20	19,5	30,5	20
17,5	19	18,5	19,5	18,5	18,5	18,5	18,5	19,5	18,5	18,5	18,5	19,5	18	18,5	18		18	18		18
17,7	18,6	18,5	19,2	18,4	18,5	18,5	18,9	19,6	18,5	18,1	18,5	19,6	17,9	18,4	18		17,7	17,8		17,9
18	17	17	17,5	17,4	16,5	17,1	17,1	17	17,6	17,5	17	17	18,2	18	16,2	18	18	18	20,5	17
5,5	5,5	5,9	5,7	5,6		5,5	5,5	5,5	5,5	5,8	5,5	5,5	5,6	5,3	5	5,8	5,5	5,5	5	4,9
21,8	21,6	22,1	21,9	22,1	22,2	21,3	21	22	21,9	22,5	22	22	22,5	21,4	21,8		22,5	21,6		
																26,7			26,7	
28,8	28,9	27,8	28,2	28,9	28,5	29,1	28,7	28,8	28,9	29,2	33,5	28,8	30,8	30,9	32,8	29,9	30,5	28,9	30,5	27,9
23,2	23,5	24	23,4	23,2	23,9	23,3	23,6	23,8	23,5	23,4	24,5	23,8	23,5	23,2	24,5	25,6	23,4	23,4	25,7	23,5
25,1	26,2	24	25,6	25,2	25,6	25,6	25,1	26	25,3	23,9	25,8	26	25,3	23,5	26,3	28,2	26,7	25,1	28,1	28,2
25,3	25	32,5	25,1	24,7	31,8	25,2	29,8	29,3	24,4	25,2	29,3	29,3	26,7	32	24,7	31,8	25,5	25,3	31,5	32,3
	25				31,8							29,3				31,8				
23	22,5	27	22,5	22	27,5	22,5	25	25	22	22,5	25,5	25	24,1	27	22,3	28	23	23	28	28
	22,5				27,5							25				28				
12,5	13	12,2	12,2	12,3	12	12,9	12,6	12,6	12,2	12,7	15	12,6	12,9	12	13	16	13	12,8	14	13,9
9,2	9,5	9,5	9,5	9,3	11,9	9,7	9,6	9,6	9,4	10	9,5	9,6	9,5	9,4	9,5	9,5	9,2	9,3	9,5	11,6



Children's Sets | Couverts pour enfants
Cubiertos para niños | Posate per bambini

	Child set, 3 pcs. Couvert pour enfants, 3 pcs. Cubierto para niño, 3 piezas. Posate per bambini, 3 pezzi.	Child set, 4 pcs. Couvert pour enfants, 4 pcs. Cubierto para niño, 4 piezas. Posate per bambini, 4 pezzi.	Child's cup* + spoon Gobelet pour enfants* + cuiller Taza niños* + cucharilla Bicchiere per bambini* + cucchiaio				
Cutlery series Série de couverts Cubertería Gamma di posate	925 Sterling Silver	150 massive silver plated	925 Sterling Silver	150 massive silver plated	925 Sterling Silver	150 massive silver plated	
Alta		05003,03,1	05002,03,1	05003,04,3	05002,04,3	05003,02,39	05002,02,37
Alt-Chippendale		05303,03,1	05302,03,1	05303,04,2	05302,04,2	05303,02,40	05302,02,38
Alt-Faden		04503,03,1	04502,03,1	04503,04,2	04502,04,2	04503,02,40	04502,02,38
Alt-Kopenhagen		04003,03,1	04002,03,1	04003,04,2	04002,04,2	04003,02,40	04002,02,38
Alt-Spaten		01903,03,1	01902,03,1	01903,04,2	01902,04,2	01903,02,40	01902,02,38
Avenue		04403,03,1	04402,03,1	04403,04,10	04402,04,9	04403,02,40	04402,02,38
Classic-Faden		05703,03,1	05702,03,1	05703,04,2	05702,04,2	05703,02,40	05702,02,38
Französisch-Perl		04603,03,1	04602,03,1	04603,04,2	04602,04,2	04603,02,40	04602,02,38
Martelé		06303,03,1	06302,03,1	06303,04,2	06303,04,2	06303,02,40	06302,02,38
Navette		04803,03,1	04802,03,1	04803,04,2	04802,04,2	04803,02,40	04802,02,38
Ostfriesen		01003,03,1	01002,03,1	01003,04,2	01002,04,2	01003,02,40	01002,02,38
Rosenmuster		03803,03,1	03802,03,1	03803,04,2	03802,04,2	03803,02,40	03802,02,38
Spaten		02003,03,1	02002,03,1	02003,04,2	02002,04,2	02003,02,40	02002,02,38
Sphinx		06903,03,1	06902,03,1	06903,04,2	06902,04,2	06903,02,40	06902,02,38

* 90 silver plated

Stainless steel cutlery | Couverts acier massif | Cuberterías acero inoxidable | Reposate Inox 18/8

Cutlery series Série de couverts Cubertería Gamma di posate		Child set, 3 pcs. Couvert pour enfants, 3 pcs. Cubierto para niño, 3 piezas. Posate per bambini, 3 pezzi.	Child set, 4 pcs. Couvert pour enfants, 4 pcs. Cubierto para niño, 4 piezas. Posate per bambini, 4 pezzi.
Como		05106,03,2	05106,04,7
Jardin		06506,03,2	06506,04,7
Lago		06606,03,2	06606,04,7
Ostfriesen		01006,03,2	01006,04,7
Topos		05906,03,2	05906,04,7
York		03706,03,2	03706,04,7



Baby set, 2 pcs. | Couvert pour bebe, 2 pcs.
 Juego bebé, 2 piezas. | Posate per neonato, 2 pez.

Spaten

02003,1718,1

02002,1718,1



Birth spoon | Cuiller de naissance
 Cuchara de nacimiento | Cucchiaino per la nascita

Boy
 Garçon
 Niño
 Maschietto

51403001

51402001

Girl
 Fille
 Niña
 Femminuccia

51403002

51402002



Alta

Small bowl
 Jatte
 Bol pequeño
 Coppetta

Ø 16 cm

05003540
 (285 g)

90 silver
 plated

Small plate
 Petite assiette
 Plata niños
 Piattino

Ø 19 cm

05003522
 (250 g)

05001540

Child's cup
 Gobelet pour enfants
 Taza niños
 Bicchiere per bambini

Ø 6,8 cm, 6,5 cm

05003552
 (125 g)

05001552

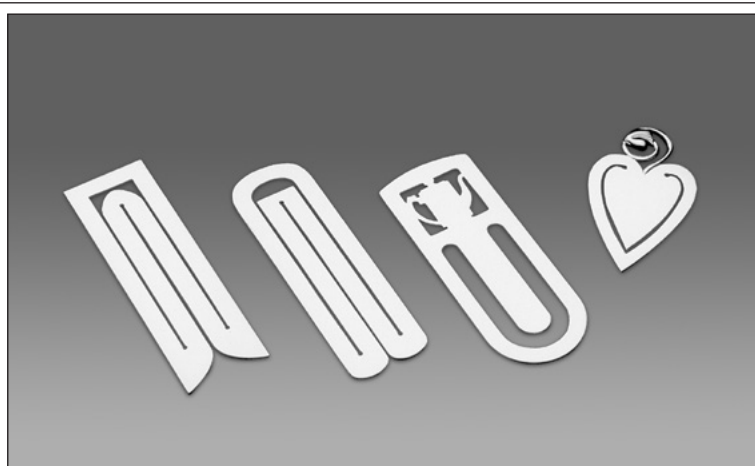

Book-marker | Signet | Marcapáginas | Segnalibro

♂

50403001

50401001

♀

50403002

50401006

Mocha pot | cafetière à moka
 cafetara | Caffettiera da moca

50403005

50401005

Heart | Coeur | Corazón | Cuore

50403003

50401007



Silver care products / Cases | Entretien et entreposage d'argenterie
Cuidado y conservación de plata | Manutenzione e custodia per le posate di argento



Cases | Coffrets | Estuches | Astucci

4-piece case | Coffret pour 4 pièces | Estuche, 4 piezas
Astuccio, posate tavola 4 pos.

19 x 26,5 x 4,5 cm

Suitable for | Utilisable pour | Para guardar
Composte da: 1x (04) (05) (06) (21)

31080001

24/30-piece box | Coffret pour 24 et 30 pièces
Caja, 24 piezas o 30 piezas
Cassetta, servizio tavola 24 o 30 pos.

41,5 x 34,0 x 7,0 cm

Suitable for | Utilisable pour | Para guardar
Composte da: 6x (04) (05) (06) (21) (27)

30270030

9-piece box | Coffret pour 9 pièces | Caja, 9 piezas
Cassetta, servizio tavola 9 pos.

41,5 x 34,0 x 7,0 cm

Suitable for | Utilisable pour | Para guardar | Composte da: 2x (31),
1x (33) (38) (44) (25) (35) (52) (64)

30270109



Cloth pouches | Trousses
Bolsas | Buste da posate

Suitable for | Utilisable pour | Para guardar | Composte da:

1x (4) / (5)

31708101

1x (6)

31708102

1x (20) / (27)

31708103

1 large serving item | 1 grande pièce à servir | 1 pieza de servir grande
Grosse posate oppure posto tavola

31708104

1x (36) / (47)

31708105

12x (4)

31708001

12x (5) / (6)

31708002

12x (20) / (27)

31708003

6 large serving items | 6 grandes pièces à servir | 6 piezas de servir grandes
Posate da servire oppure posto tavola

31708004

1x (4), (5), (6), (20), 27)

31708020

Covering cloth | Carrées de toile
Paños protectores | Panno da coprire

36,0 x 28,5 cm

31708014

36,0 x 25,5 cm

31708016

40,0 x 30,5 cm

31708017

52,0 x 29,5 cm

31708018

51,5 x 38,5 cm

31708019



Silver care products | Des produits d'entretien d'argenterie
Serie de cuidado de plata | Linea di manutenzione

Silver polishing cloth | Chiffon spécial pour l'argenterie
Paño limpiaplata | Panno per lustrare

30408030

Silver polish | Produit de polissage d'argenterie
Detergente para plata | Lucido per argento 250 ml

30408032

Polishing mitt | Gant pour nettoyer
Guante para limpiar | Guanto per lustrare

30408034

Set composition and storage boxes
 Assortiment de garnitures et coffrets de rangement
 Conjunto de accesorios y cajas de almacenamiento
 Set di accessori e contenitori per la conservazione



Mahogany | Acajou | Caoba | Acagiù

Red lacquered | Laque Rouge | Lacada en rojo | Verniciato rosso

39 pcs. pcs. pzs. pz.	43,8 cm x 33,5 cm x 24,8 cm	Nr. 30271039*
69 pcs. pcs. pzs. pz.	49,5 cm x 38,5 cm x 25,8 cm	Nr. 30271169*
133 pcs. pcs. pzs. pz.	61,0 cm x 37,0 cm x 33,8 cm	Nr. 30271133**
185 pcs. pcs. pzs. pz.	61,0 cm x 46,0 cm x 56,8 cm	Nr. 30271185**
263 pcs. pcs. pzs. pz.	61,0 cm x 46,0 cm x 56,8 cm	Nr. 30271263***

39 pcs. pcs. pzs. pz.	43,5 cm x 35,0 cm x 22,0 cm	Nr. 30272039*
69 pcs. pcs. pzs. pz.	47,2 cm x 40,0 cm x 22,5 cm	Nr. 30272069*
133 pcs. pcs. pzs. pz.	60,0 cm x 36,5 cm x 37,5 cm	Nr. 30272133**

- * 2 drawers | 2 tiroirs | 2 cajones | 2 cassetti
- ** 3 drawers | 3 tiroirs | 3 cajones | 3 cassetti
- *** 5 drawers | 5 tiroirs | 5 cajones | 5 cassetti

All cutlery canteens can be individually configured to suit the cutlery that you have ordered.
 L'agencement de toutes les ménagères peut être personnalisé en fonction des couverts que vous avez achetés.
 Todos los estuches pueden personalizarse también acordes a las piezas de cubertería adquiridas
 Tutte le cassette possono essere preparate anche individualmente secondo le posate da voi acquistate.

		9	24	30	39	69	133	185	263
004	Menu spoon Cuiller à menu Cuchara mesa Cucchiaino tavola		6	6	6	12	12	12	18
005	Menu fork Fourchette à menu Tenedor mesa Forchetta tavola		6	6	6	12	12	12	18
006	Menu knife Couteau à menu Cuchillo mesa Coltello tavola		6	6	6	12	12	12	18
007	Dessert spoon Cuiller à dessert Cuchara postre/entremés Cucchiaino frutta						12	12	18
008	Dessert fork Fourchette à dessert Tenedor postre/entremés Forchetta frutta						12	12	18
009	Dessert knife Couteau à dessert Cuchillo postre/entremés Coltello frutta						12	12	18
021	Coffee spoon Cuiller à café Cuchara café Cucchiaino caffè-tè		6	6	6	12	12	12	18
023	Mocha-/espresso spoon Cuiller à moka Cuchara moca Cucchiaino moca/espresso							12	18
027	Cake fork, large Fourchette à gâteaux, grande Tenedor tarta Forchetta dolci			6	6	12	12	12	18
026	Ice-cream spoon Cuiller à glace Cuchara helado Cucchiaino gelato							12	18
010	Fish knife Couteau à poisson Cuchillo pescado Coltello pesce						12	12	18
011	Fish fork Fourchette à poisson Tenedor pescado Forchetta pesce						12	12	18
025	Broth spoon Cuiller à consommé Cuchara taza Cucchiaino brodo/panna							12	18
091/092	Butter/cheese knife Couteau à beurre et à fromage Cubierto de mantequilla y queso Coltello burro/formaggio						1	2	2
045/046	Fish serving knife and fork Service à poisson Cubierto servir pescado Coltello e forch. servire pesce							1	1
031	Meat fork, large Fourchette à viande, grande Tenedor carne, grande Forchetta carne, grande		2		2	2	2	4	4
038	Serving fork Fourchette à servir Tenedor para servir Forchetta per servire		1		1	1	1	2	2
039	Serving spoon Cuiller à servir Cuchara servir Cucchiaino servire		1		1	1	1	2	2
044	Serving spoon, large Cuiller à servir, grande Cuchara servir Cucchiaino servire, gr.		1		1	1			
025	Cream spoon Cuiller à crème Cuchara nata Cucchiaino brodo/panna		1		1	1	1		
040/041	Salad serving set, large Service à salade, grande Cubierto ensalada, grande Cucch. e forch. serv. ins., gr.						1	2	2
035	Sauce ladle Cuiller à sauce Cuchara salsa Cucchiaino salsa		1		1	1	1	2	2
036	Soup ladle Louche Cazo sopa Mestolo						1	1	1
052	Tart server Pelle à tarte Pala tarta Pala torta		1		1	1	1	2	2
054	Tart knife Couteau à tarte Cuchillo tarta Coltello torta							2	2
048/049	Carving knife and fork Service à découper Cubierto trinchar Coltello e forchetta trinciante							1	1
064	Sugar spoon Cuiller à sucre Cucharilla azúcar Cucchiaino zucchero		1		1	1	1		
065	Sugar tongs Pince à sucre Pinzas azúcar Pinza zucchero							2	2



Stainless steel cutlery
Couverts acier massif
Cuberterías acero inoxidable
Reposate Inox 18/8



Atlantic-Brilliant

058.06



Atlantic*

052.06



Baltic

047.06

3-pc. children's set Couvert pour enfants à 3 pcs. 3 pz. Set infantil Posate per bambini, 3 pos.			
4-pc. children's set Couvert pour enfants à 4 pcs. 4 pz. Set infantil Posate per bambini, 4 pos.			
24-piece set Service à Menu 24 pièces 24 piezas Cuberteria de mesa Servizio tavola 24 pos. 6 x Art-No. 004, 005, 006, 021 Canteen Coffre Caja Cassetta 30276030	●	●	●
30-piece set Service à Menu 30 pièces 30 piezas Cuberteria de mesa Servizio tavola 30 pos. 6 x Art-No. 004, 005, 006, 021, 027 Canteen Coffre Caja Cassetta 30276030	●	●	●
10 Serving pieces 10 Pièces pour servir 10 Piezas de servir 10 Posate da servire 2 x Art-No. 031, 1 x 025, 1 x 040/041, 2 x 039, 1 x 035, 1 x 052, 1 x 064 Canteen Coffre Caja Cassetta 30276010	●	●	●
70-piece set Service à Menu 70 pièces 70 piezas Cuberteria de mesa Servizio tavola 70 pos. 12 x Art-No. 004, 005, 006, 021, 027, 2 x 031, 1 x 025, 1 x 040/041, 2 x 039, 1 x 035, 1 x 052, 1 x 064	●	●	●
75-piece set Service à Menu 75 pièces 75 piezas Cuberteria de mesa Servizio tavola 75 pos. 12 x Art-No. 004, 005, 006, 008, 009, 021, 1 x 039, 1 x 038, 1 x 036	●	●	●
128-piece set Service à Menu 128 pièces 128 piezas Cuberteria de mesa Servizio tavola 128 pos. 12 x Art-No. 004, 005, 006, 007, 008, 009, 021, 027, 010, 011, 1 x 052, 1 x 065, 1 x 036, 1 x 035, 2 x 039 und 1 x 040/041	●	●	●

* matt finished | mat | cepillado mate | opaco refinito

Art. No. Art. Nr. Ref. Art. no.			
004 Menu spoon Cuiller à menu Cuchara mesa Cucchiaino tavola	●	●	●
005 Menu fork Fourchette à menu Tenedor mesa Forchetta tavola	●	●	●
006 Menu knife Couteau à menu Cuchillo mesa Coltello tavola	●	●	●
007 Dessert spoon Cuiller à dessert Cuchara postre/entremés Cucchiaino frutta	●	●	●
008 Dessert fork Fourchette à dessert Tenedor postre/entremés Forchetta frutta	●	●	●
009 Dessert knife Couteau à dessert Cuchillo postre/entremés Coltello frutta	●	●	●
020 Coffee spoon, large Cuiller à café, grande Cuchara café, grande Cucchiaino tè e colazione	●	●	●
021 Coffee spoon Cuiller à café Cuchara café Cucchiaino caffè-tè	●	●	●
022 Tea spoon III Cuiller à thé Cuchara té Cucchiaino tè			
023 Mocha-/espresso spoon Cuiller à moka Cuchara moca Cucchiaino moca/espresso	●	●	●
027 Cake fork, large Fourchette à gâteaux, grande Tenedor tarta Forchetta dolci	●	●	●
010 Fish knife Couteau à poisson Cuchillo pescado Coltello pesce	●	●	●
011 Fish fork Fourchette à poisson Tenedor pescado Forchetta pesce	●	●	●
097 Gourmet spoon Cuiller gourmet Cuchara gourmet Cucchiaino salsa individuale	●	●	
068 Fruit knife Couteau à fruits Cuchillo fruta Coltello dolci	●	●	●
084 Steak knife Couteau à steak Cuchillo steak Coltello bistecca	●	●	●
025 Broth spoon Cuiller à consommé Cuchara taza Cucchiaino brodo/panna	●	●	●
071/072 Butter/cheese knife Couteau à beurre et à fromage Cubierto de mantequilla y queso Coltello burro/formaggio			
091/092 Butter and cheese knife, hollow handle dito, lame inox idem, con hoja de acero Coltello burro/formaggio	●	●	●
031 Meat fork, large Fourchette à viande, grande Tenedor carne, grande Forchetta carne, grande	●	●	●
032 Meat fork, small dito, petite idem, pequeño Forchetta carne, piccola	●	●	
050 Pastry server Pelle à gâteaux Pala bizcocho Pala dolci	●	●	
038 Vegetable fork Fourchette à légumes Tenedor verdura Forchetta legumi	●	●	●
014 Children's spoon Cuiller pour enfants Cuchara infantil Cucchiaino per bambini			
015 Children's fork Fourchette pour enfants Tenedor infantil Forchetta per bambini			
016 Children's knife Couteau pour enfants Cuchillo infantil Coltello per bambini			
040 Compote spoon, large Cuiller à entremets, grande Cuchara compota, grande Cucchiaino serv. insalata, gr.	●	●	●
042 Compote spoon, small dito, petite idem, pequeña Cucchiaino serv. insalata, picc.			●
025 Cream spoon Cuiller à crème Cuchara nata Cucchiaino brodo/panna	●	●	●
061 Cream spoon, bent Cuiller à crème, cintrée Cuchara nata, curvada Cucchiaino panna, piegato			
040/041 Salad serving set, large Service à salade, grande Cubierto ensalada, grande Cucch. e forch. serv. ins., gr.	●	●	●
042/043 Salad serving set, small dito, petite idem, pequeño Cucch. e forch. serv. ins., picc.			●
035 Sauce ladle Cuiller à sauce Cuchara salsa Cucchiaino salsa	●	●	●
039 Serving Spoon Cuiller à servir Servicio vegetales Cucchiaino servire	●	●	●
036 Soup ladle Louche Cazo sopa Mestolo	●	●	●
052 Tart server Pelle à tarte Pala tarta Pala torta	●	●	●
054 Tart knife Couteau à tarte Cuchillo tarta Coltello torta	●	●	●
048/049 Carving knife and fork Service à découper Cubierto trinchar Coltello e forchetta trinciante	●	●	●
064 Sugar spoon Cuiller à sucre Cucharilla azúcar Cucchiaino zucchero	●	●	●
065 Sugar tongs Pince à sucre Pinzas azúcar Pinza zucchero	●	●	●



Bar Collection | Bar Collection | Colección del bar | Collezione da bar

150
massive
silver
plated

90
silver
plated

Martelé



1	Ice tongs Pince a glace Pinza de hielo Pinza da ghiaccio	∩ 13,0 cm	06302110	–
2	Jigger Jigger Jigger Misurino da bar	∅ 5,0 cm, ∩ 7,7 cm	–	06301510
3	Bar spoon Bar spoon Cuchara bar Cucchiaino da bar	∩ 27,0 cm	–	06301502
4	Cocktailstick Broche à cocktail Brocheta de cóctel Forchettina per cocktail	∩ 9,7 cm	51402005	–
5	Longdrink spoon Cuiller à longdrink Cuchara cocktail Cucchiaino cocktail	∩ 19,4 cm	06302066	–
6	Champagne tongs Pince à Champagne Abridor champan Apribottiglia Champagne	∩ 18,0 cm	06302313	–
7	Nutcracker Casse-noix Cascanueces Schiaccianoci	∩ 16,7 cm	06302203	–
8	Bottle-opener Ouvre-bouteille Abridor Apribottiglia	∩ 12,0 cm	06302206	–
9	Cocktailstrainer Passoire à cocktail Colador para cóctel Strainer da bar	∩ 20,5 cm	06302501	–
10	Silver straw Paille brillante Pajita Cannuccia	∩ 24,0 cm	–	50801090

Martelé



Champagne flute Coupe de champagne Copa champana Flûte Champagne	∅ 5,4 cm, ∩ 19,4 cm	–	06301598
Cocktail coupe Coupe à cocktail Copa de cóctel Coppa cocktail	∅ 11,5 cm, ∩ 12,8 cm	–	06301597

Martelé



Snackbar	↔ 11,8 cm ∩ 10,5 cm ↘ 23,8 cm	–	06301596
----------	-------------------------------------	---	----------



90
silver
plated

90
silver
plated*

Martelé



Cocktailshaker with glass Ø 9,3 cm, H 16,8 cm*
Cocktailshaker avec verre
Cóctelera con copa de cristal
Shakerati con bicchiere di vetro

06301507

–

*without glass | *sans verre | *sin copa de cristal
*senza bicchiere di vetro

Martelé



Longdrink and beer tumbler Ø 7,8 cm, H 12,0 cm
Gobelet à longdrink et bière
Copa cerveza/long drink
Tumbler long drink/birra

06301584

–

Vodkabeaker Ø 4,8 cm, H 4,5 cm
Coupe à vodka
Vaso para vodka
Bicchiere per vodka

06301581

–

Gin, water and wine tumbler Ø 7,8 cm, H 8,9 cm
Gobelet à Gin, eau et vin
Copa ginebra/vino/aqua
Bicchiere da gin/acqua/vino

06301583

–

Martelé



Rum and distillate tumbler Ø 7,1 cm, H 6,3 cm
Gobelet à rum et destillat
Copa ron/destilado
Bicchiere rum/distillato

06301582

–

Whiskey tumbler Ø 8,3 cm, H 8,0 cm
Gobelet à whiskey
Copa de whiskey
Bicchiere da whiskey

06301585

–

Martelé



Bowl with plain rim Ø 12,0 cm
Jatte avec bord plain
Bol con borde liso
Coppa con bordo liscio

06301544

06331544

Bowl with plain rim Ø 10,0 cm
Jatte avec bord plain
Bol con borde liso
Coppa con bordo liscio

06301543

06331543

Bottle-coaster Ø 14,5 cm
Sous-bouteille
Posabotella
Sottobottiglia

06301521

–

Coaster Ø 11,5 cm
Sous-verre
Bandeja para vasos
Vassoio per bicchieri

06301520

–



Bar Collection | Bar Collection | Colección del bar | Collezione da bar

150
massive
silver
plated

90
silver
plated

Belvedere



- 1 Jigger | Jigger | Jigger Ø 5,0 cm, I 7,7 cm
Misurino da bar - 06801510
- 2 Bar spoon | Bar spoon I 27,0 cm - 06801502
Cuchara bar | Cucchiaino da bar
- 3 Cocktailstick | Broche à cocktail I 9,7 cm 51402005 -
Brocheta de cóctel | Forchettina per cocktail
- 4 Champagne tongs I 18,2 cm 06802313 -
Pince à Champagne | Abridor champan
Apribottiglia Champagne
- 5 Nutcracker | Casse-noix I 16,8 cm 06802203 -
Cascanueces | Schiaccianoci
- 6 Bottle-opener | Ouvre-bouteille I 12,0 cm 06802206 -
Abridor | Apribottiglia
- 7 Cocktailstrainer I 20,5 cm 06802501 -
Passoire à cocktail | Colador para cóctel
Strainer da bar
- 8 Silver straw | Paille brillante I 24,0 cm - 50801090
Pajita | Cannuccia

Belvedere



- Champagne flute Ø 5,4 cm, I 19,4 cm - 06801598
Coupe de champagne
Copa champana
Flûte Champagne
- Cocktail coupe Ø 11,5 cm, I 12,8 cm - 06801597
Coupe à cocktail
Copa de cóctel
Coppa cocktail

Belvedere

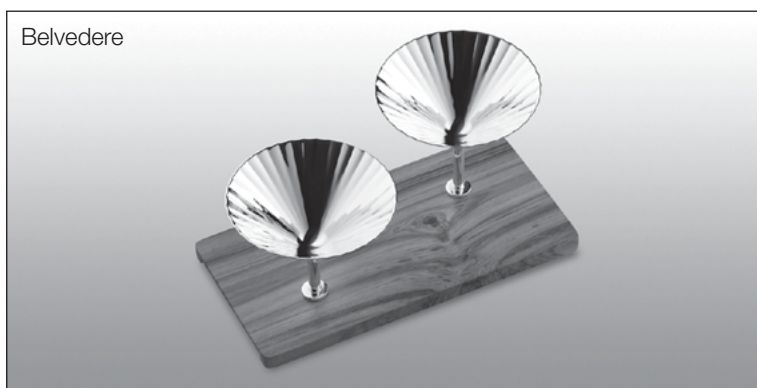

- Snackbar ↔ 11,8 cm - 06801596
I 10,5 cm
↗ 23,8 cm



Belvedere



Cocktailshaker with glass
Cocktailshaker avec verre
Cóctelera con copa de cristal
Shakerati con bicchiere di vetro

Ø 9,3 cm, I 16,8 cm*

06801507

*without glass | *sans verre | *sin copa de cristal
*zonder glas | *senza bicchiere di vetro

Belvedere



Longdrink and beer tumbler
Gobelet à longdrink et bière
Copa cerveza/long drink
Bicchiere da long drink / birra

Ø 7,8 cm, I 12,0 cm

06801584

Vodkabeaker
Coupe à vodka | Vaso para vodka
Bicchiere per vodka

Ø 4,8 cm, I 4,5 cm

06801581

Gin, water and wine tumbler
Gobelet à Gin, eau et vin
Copa ginebra/vino/aqua
Bicchiere da gin/acqua/vino

Ø 7,8 cm, I 8,9 cm

06801583

Belvedere



Rum and distillate tumbler
Gobelet à rhum et distillat
Copa ron/destilado
Bicchiere rum/distillato

Ø 7,1 cm, I 6,3 cm

06801582

Whiskey tumbler | Gobelet à whiskey
Copa de whiskey | Bicchiere da whiskey

Ø 8,3 cm, I 8,0 cm

06801585





<p>Dante</p>	<p>1 Ice tongs Pince a glace Pinza de hielo Pinza da ghiaccio</p> <p>2 Jigger Jigger ∅ 5,0 cm, I 7,7 cm Jigger Misurino da bar</p> <p>3 Bar spoon Bar spoon I 27,0 cm Cuchara bar Cucchiaino da bar</p> <p>4 Cocktailstick I 9,7 cm Broche à cocktail Brocheta de cóctel Forchettina per cocktail</p> <p>5 Longdrink spoon I 19,8 cm Cuiller à longdrink Cuchara cocktail Cucchiaino cocktail</p> <p>6 Champagne tongs I 18,0 cm Pince à Champagne Abridor champan Apribottiglia Champagne</p> <p>7 Nutcracker Casse-noix I 16,7 cm Cascanueces Schiaccianoci</p> <p>8 Bottle-opener I 12,3 cm Ouvre-bouteille Abridor Apribottiglia</p> <p>9 Cocktailstrainer I 20,2 cm Passoire à cocktail Colador para cóctel Strainer da bar</p> <p>10 Silver straw Paille brillante I 24,0 cm Pajita Rietje Cannuccia</p>	<p>06202110</p> <p>–</p> <p>–</p> <p>–</p> <p>51402005</p> <p>06202066</p> <p>06202313</p> <p>06202203</p> <p>06202206</p> <p>06202501</p> <p>–</p>	<p>–</p> <p>06201510</p> <p>06201502</p> <p>–</p> <p>–</p> <p>–</p> <p>–</p> <p>–</p> <p>–</p> <p>–</p> <p>50801090</p> <p>–</p>	<p>–</p> <p>06231510</p> <p>–</p> <p>–</p> <p>–</p> <p>–</p> <p>–</p> <p>–</p> <p>–</p> <p>–</p> <p>–</p>
<p>Dante</p>	<p>Champagne flute ∅ 5,4 cm, I 19,4 cm Coupe de champagne Copa champana Flûte Champagne</p> <p>Cocktail coupe ∅ 11,5 cm, I 12,8 cm Coupe à cocktail Copa de cóctel Coppa cocktail</p>	<p>–</p> <p>–</p>	<p>06201598</p> <p>06201597</p>	<p>06231598</p> <p>06231597</p>
<p>Dante</p>	<p>Snackbar ↔ 11,8 cm I 10,5 cm ↘ 23,8 cm</p>	<p>–</p>	<p>06201596</p>	<p>06231596</p>



90
silver
plated

90
silver
plated*

<p>Dante</p> 	<p>Cocktailshaker with glass Ø 9,3 cm, H 16,8 cm*</p> <p>Cocktailshaker avec verre</p> <p>Cóctelera con copa de cristal</p> <p>Shakerati con bicchiere di vetro</p> <p>*without glass *sans verre *sin copa de cristal</p> <p>*senza vicchiere di vetro</p>	<p>06201507</p>	<p>—</p>
<p>Dante</p> 	<p>Longdrink and beer tumbler Ø 7,8 cm, H 12,0 cm</p> <p>Gobelet à longdrink et bière</p> <p>Copa cerveza/long drink</p> <p>Bicchiere da long drink / birra</p> <p>Vodkabeaker Ø 4,8 cm, H 4,5 cm</p> <p>Coupe à vodka</p> <p>Vaso para vodka</p> <p>Bicchiere per vodka</p> <p>Gin, water and wine tumbler Ø 7,8 cm, H 8,9 cm</p> <p>Gobelet à Gin, eau et vin</p> <p>Copa ginebra/vino/aqua</p> <p>Bicchiere da gin/acqua/vino</p>	<p>06201584</p> <p>06201581</p> <p>06201583</p>	<p>06231584</p> <p>06231581</p> <p>06231583</p>
<p>Dante</p> 	<p>Rum and distillate tumbler Ø 7,1 cm, H 6,3 cm</p> <p>Gobelet à rhum et distillat</p> <p>Copa ron/destilado</p> <p>Bicchiere rum/distillato</p> <p>Whiskey tumbler Ø 8,3 cm, H 8,0 cm</p> <p>Gobelet à whiskey</p> <p>Copa de whiskey</p> <p>Bicchiere da whiskey</p>	<p>06201582</p> <p>06201585</p>	<p>06231582</p> <p>06231585</p>
<p>Dante</p> 	<p>Coaster Ø 11,5 cm</p> <p>Sous-verre</p> <p>Bandeja para vasos</p> <p>Sottobicchiere</p> <p>Bottle-coaster Ø 14,5 cm</p> <p>Sous-bouteille</p> <p>Posabotella</p> <p>Sottobottiglia</p>	<p>06201520</p> <p>06201521</p>	<p>—</p> <p>—</p>



Champagne flute
Coupe de champagne
Copa champana
Flûte Champagne

Ø 5 cm, I 25 cm

05003598
(275 g)

05001598



Champagne cooler
Seau à champagne
Cubo para champaña
Secchiello per champagne

Ø 19,7 cm, I 21,5 cm

–

50801025

Ice bucket
Seau à glace
Cubo de hielo
Secchio da ghiaccio

Ø 13,0 cm, I 13,5 cm

–

50801125

Ice bucket lid
Couvercle pour seau à glace
Tapadera para cubo de hielo
copercchio per secchio da ghiaccio

–

50801126



Martelé

Martelé

Champagne cooler
Seau à champagne
Cubo para champaña
Secchiello per champagne

Ø 19,7 cm, I 21,5 cm

–

06301587

Ice bucket
Seau à glace
Cubo de hielo
Secchio da ghiaccio

Ø 13,0 cm, I 13,5 cm

–

06301588

Ice bucket lid
Couvercle pour seau à glace
Tapadera para cubo de hielo
copercchio per secchio da ghiaccio

–

06301589

Ice tongs | Pince a glace | Pinza de hielo
Pinza da ghiaccio

–

06302110



150



Champagne cooler
with handles
Seau à champagne avec poignées
Cubo para champaña con asas
Secchiello per champagne con manici

Ø 20 cm, I 20 cm

50803012
(1.500 g)

50801012

Ice bucket II
Seau à glace II
Cubo de hielo II
Secchio da ghiaccio II

Ø 13,5 cm, I 13,5 cm

–

50801026

Ice bucket lid II
Couvercle pour seau à glace II
Tapadera para cubo de hielo II
copercchio per secchio da ghiaccio II

–

50801027

Ice tongs | Pince a glace | Pinza de hielo
Pinza da ghiaccio

–

05002110



150



Gourmet cone, Cornet à gourmet,
Cono de gourmet, Cono gourmet

–

06301545

Gourmet spoon, Cuiller gourmet,
Cuchara gourmet, Cuchara gourmet

–

05402007



Gourmet cone stand,
Support pour cornet à gourmet,
Soporte para cono de gourmet,
Appoggio da coni Gourmet

 32908076

 32908077

 32908078

 32908079

Alta

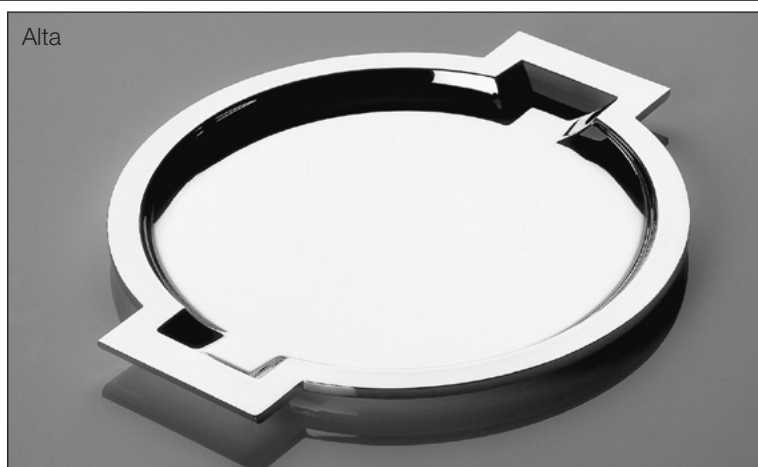

Service tray, round
Plateau à servir, rond
Banjeda de servicio, redondo
Vassoio di servizio, rotondo

Ø 32 cm

05003528
(1.010 g)

05001528

Ø 24 cm

05003527
(620 g)

05001527



Vodkabeaker
(with picture of one's choice)

Ø 5,2 cm, H 5,4 cm

50803017
(64 g)

50801017

Coupe à vodka
(avec motif souhaité)

Vaso para vodka
(con motivo usted desea)

Bicchieri per vodka
(con disegno à richiesta)



Taste-Vin

Ø 8 cm

51403016

51401016

Corkscrew
Tire-bouchon
Sacacorchos
Cavatappi

51403022

51401022



Bar Cart | Chariot de bar | Carro de bar | Carrello bar



Bar Cart | Chariot de bar | Carro de bar | Carrello bar

Beige railing

30108232

Material | Matériau | Material | Materiale

Wheels and body: Thermo ash (oiled)
Roues et carrosserie: Frêne thermo (huilé)
Ruedas y carrocería: Termo ceniza (aceitado)
Ruote e corpo: Frassino termico (oliato)

Railing: Stainless steel covered with nappa leather
Balustrade: Acier inoxydable recouvert de cuir nappa
Barandilla: Acero inoxidable recubierto de nappa
Ringhiera: Acciaio inossidabile ricoperto di nappa

Weight | Poids | Peso | Peso approx. 29 kg | environ 29 kg
aprox. 29 kg | circa 29 kg

Trolley dimensions: ↗ 920 x ↔ 576 x ⊥ 885 mm
Dimensions du chariot:
Dimensiones del carro:
Dimensioni del carrello:

Individualisation option: Placement of your logo on both sides of the trolley
Option d'individualisation: Placement de votre logo sur les deux côtés du chariot
Opción de individualización: Colocación de su logotipo en ambos lados del carro
Opzione di personalizzazione: Posizionamento del vostro logo su entrambi i lati del carrello

Locking wheel/brake: available
Roue/frein de blocage: disponible
Bloqueo de la rueda/freno: disponible
Bloccaggio ruota/freno: disponibile





Bar Cart | Chariot de bar | Carro de bar | Carrello bar

Black railing

30108234

Material | Matériau | Material | Materiale

Wheels and body: Oak (oiled)
 Roues et carrosserie: Chêne (huilé)
 Ruedas y carrocería: Roble (aceitado)
 Ruote e corpo: Rovere (oliato)

Railing: Stainless steel covered with nappa leather
 Balustrade: Acier inoxydable recouvert de cuir nappa
 Barandilla: Acero inoxidable recubierto de napa
 Ringhiera: Acciaio inossidabile ricoperto di nappa

Weight | Poids: approx. 29 kg | environ 29 kg
 Peso | Peso: approx. 29 kg | circa 29 kg

Trolley dimensions: ↗ 920 x ↔ 576 x ↓ 885 mm
 Dimensions du chariot:
 Dimensiones del carro:
 Dimensioni del carrello:

Individualisation option: Placement of your logo on both sides of the trolley
 Option d'individualisation: Placement de votre logo sur les deux côtés du chariot
 Opción de individualización: Colocación de su logotipo en ambos lados del carro
 Opzione di personalizzazione: Posizionamento del vostro logo su entrambi i lati del carrello

Locking wheel/brake: available
 Roue/frein de blocage: disponible
 Bloqueo de la rueda/freno: disponible
 Bloccaggio ruota/freno: disponibile





The Box

925
Sterling
Silver

150
massive
silver
plated

90
silver
plated*



24-piece set | Ensemble de 24 pièces Juego de 24 piezas | Set da 24 pezzi

Content | Contenu | Contenido | Contenuto
6x Menu spoon | 6x Cuiller à menu | 6x Cuchara mesa | 6x Cucchiaino tavola
6x Menu fork | 6x Fourchette à menu | 6x Tenedor mesa | 6x Forchetta tavola
6x Menu knife | 6x Couteau à menu | 6x Cuchillo mesa | 6x Coltello tavola
6x Coffee spoon | 6x Cuiller à café | 6x Cuchara café | 6x Cucchiaino caffè-tè

With shiny blades | Avec des lames brillantes Con hojas brillantes | Con lame lucide

• Alta	05003,24,1	05002,24,1
• Arcade	05603,24,1	05602,24,1
• Art Deco	06003,24,1	06002,24,1
• Alt-Chippendale	05303,24,1	05302,24,1
• Alt-Spaten	01903,24,1	01902,24,1
• Avenue	04403,24,1	04402,24,1
• Belvedere	06803,24,1	06802,24,1
• Dante	06203,24,1	06202,24,1
• Eclipse	07103,24,1	07102,24,1
• Martelé	06303,24,1	06302,24,1
• Metropolitan	07303,24,1	07302,24,1
• Ostfriesen	01003,24,4	01002,24,4
• Riva	06403,24,1	06402,24,1
• Rosenmuster	03803,24,1	03802,24,1
• Spaten	02003,24,1	02002,24,1
• Viva	05503,24,1	05502,24,1

With Frozen Black knife blades Avec des lames de couteau Frozen Black Con hojas de cuchillo Frozen Black Con lame di coltello Frozen Black

• Belvedere	06803,24,8	06802,24,8
• Martelé	06303,24,8	06302,24,8
• Riva	06403,24,8	06402,24,8

THE BOX

Available only in combination with a silver or silverplated 24-piece set from one of the collections listed above.

Disponible uniquement en combinaison avec un set de 24 pièces en argent ou métal argenté d'une des collections ci-dessus.

Disponible sólo en combinación con un juego de 24 piezas en plata o plateado de una de las colecciones mencionadas anteriormente.

Disponibile solo in combinazione con un set di 24 pezzi in argento o argentato di una delle collezioni sopra elencate.

↑ 30,0 cm, ↔ 20,4 cm, ↗ 20,4 cm

The Box
anthracite, anthracite, antracita, antracite 30270224

The Box
cream, crème, crema, crema 30270228

**Please specify the THE BOX item number along with the set.
Veuillez indiquer la référence THE BOX ainsi que la garniture.
Indique el número de referencia de THE BOX junto con el juego.
Si prega di indicare il codice articolo THE BOX con il set.**



Champagne Box



CHAMPAGNE BOX anthracite, anthracite, antracita, antracite

Including four silver-plated flutes from the collections:
Avec quatre flutes argentés des collections :
Con cuatro copas champana plateadas de las colecciones:
Con quattro flute champagne argentati delle collezioni:

- Martelé
- Belvedere
- Dante

06301,4,1
06801,4,1
06201,4,1

CHAMPAGNE BOX cream, crème, crema, crema

Including four silver-plated flutes from the collections:
Avec quatre flutes argentés des collections :
Con cuatro copas champana plateadas de las colecciones:
Con quattro flute champagne argentati delle collezioni:

- Martelé
- Belvedere
- Dante

06301,4,2
06801,4,2
06201,4,2



<p>Alt-Spaten</p> 		<p>Carving set (Frozen Black), 2pcs. Set à découper (Frozen Black), 2pcs. Juego de trinchar (Frozen Black), 2piez. Set da intaglio (Frozen Black), 2pez. 1x Carving fork Fourchette à découper Tenedor trinchar Forchetta trinciante, 1x Carving knife Couteau à découper Cuchillo trinchar Coltello trinciante</p> <p>Barbecue set (Frozen Black), 4pcs. Set de barbecue (Frozen Black), 4pcs. Set de barbacoa (Frozen Black), 4piez. Set da barbecue (Frozen Black), 4pez. 2x Menu fork Fourchette à menu Tenedor mesa Forchetta tavola, 2x Steak knife Couteau à steak Cuchillo steak Coltello bistecca</p> <p>8pcs. 8pcs. 8piez. 8pez.</p>	<p>01903,02,45</p> <p>01903,04,20</p> <p>01903,08,1</p>	<p>01902,02,45</p> <p>01902,04,20</p> <p>01902,08,1</p>
<p>Martelé</p> 		<p>Carving set (Frozen Black), 2pcs. Set à découper (Frozen Black), 2pcs. Juego de trinchar (Frozen Black), 2piez. Set da intaglio (Frozen Black), 2pez. 1x Carving fork Fourchette à découper Tenedor trinchar Forchetta trinciante, 1x Carving knife Couteau à découper Cuchillo trinchar Coltello trinciante</p> <p>Barbecue set (Frozen Black), 4pcs. Set de barbecue (Frozen Black), 4pcs. Set de barbacoa (Frozen Black), 4piez. Set da barbecue (Frozen Black), 4pez. 2x Menu fork Fourchette à menu Tenedor mesa Forchetta tavola, 2x Steak knife Couteau à steak Cuchillo steak Coltello bistecca</p> <p>8pcs. 8pcs. 8piez. 8pez.</p>	<p>06303,02,45</p> <p>06303,04,20</p> <p>06303,08,1</p>	<p>06302,02,45</p> <p>06302,04,20</p> <p>06302,08,1</p>
<p>Riva</p> 		<p>Carving set (Frozen Black), 2pcs. Set à découper (Frozen Black), 2pcs. Juego de trinchar (Frozen Black), 2piez. Set da intaglio (Frozen Black), 2pez. 1x Carving fork Fourchette à découper Tenedor trinchar Forchetta trinciante, 1x Carving knife Couteau à découper Cuchillo trinchar Coltello trinciante</p> <p>Barbecue set (Frozen Black), 4pcs. Set de barbecue (Frozen Black), 4pcs. Set de barbacoa (Frozen Black), 4piez. Set da barbecue (Frozen Black), 4pez. 2x Menu fork Fourchette à menu Tenedor mesa Forchetta tavola, 2x Steak knife Couteau à steak Cuchillo steak Coltello bistecca</p> <p>8pcs. 8pcs. 8piez. 8pez.</p>	<p>06403,02,45</p> <p>06403,04,20</p> <p>06403,08,1</p>	<p>06402,02,45</p> <p>06402,04,20</p> <p>06402,08,1</p>
	<p>Wooden bowls Jattes en bois Bol de madera Coppa di legno 12</p> <p>Bowl (teak) Jatte (teck) Bol (teca) Coppa (teak) ↗ ca. 29,0 cm 51402040 ↔ ca. 6,9 cm</p> <p>Bowl (acacia) Jatte (acacia) Bol (acacia) Coppa (acacia) ↗ 29,0 cm 51402041 ↔ ca. 6,9 cm</p> <p>Bowl (teak), large Jatte (teck), grande Bol (teca), grande Coppa (teak), grande ↗ ca. 38,0 cm 51402042 ↔ ca. 8,8 cm</p> <p>Bowl (acacia), large Jatte (acacia), grande Bol (acacia), grande Coppa (acacia), grande ↗ 38,0 cm 51402043 ↔ ca. 8,8 cm</p>			



Gourmet Collection | Collection gourmet
 Colección gourmet | Collezione gourmet

925
 Sterling
 Silver

150
 massive
 silver
 plated

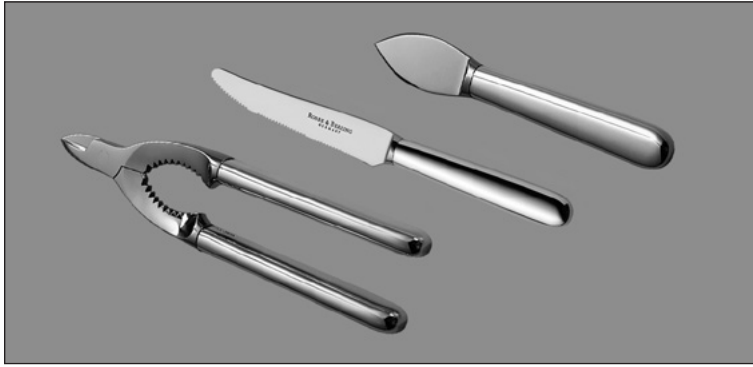

Parmesanknife Cuchillo parmesano	Couteau à parmesan Coltello per parmigiano	06203312	06202312
Tomato knife Cuchillo de tomate	Couteau à tomates Coltello per pomodori	06203378	06202378
Champagne tongs Abridor champán	Pince à champagne Apribottiglia Champagne	06203313	06202313

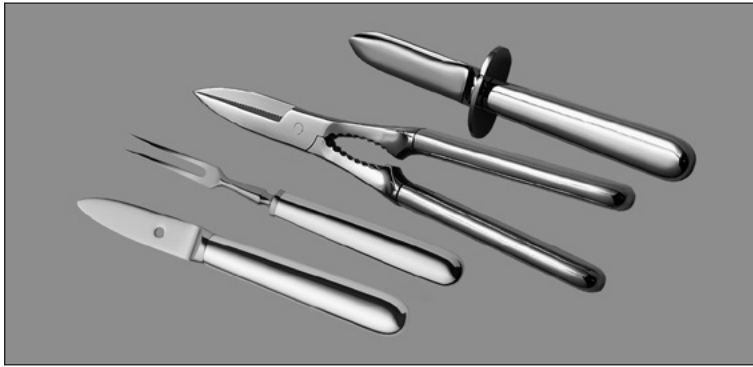

Oyster knife Cuchillo de ostras	Couteau à huîtres Coltello per ostriche	06203376	06202376
Lobster tongs Tenazas langosta	Pince à crustacés Pinza per astice	06203357	06202357
Escargot fork Tenedor caracoles	Fourchette à escargot Slakkenvork	06203390	06202390
Crab knife Cuchillo cangrejo	Couteau à écrevisse Coltello per gamberi	06203389	06202389

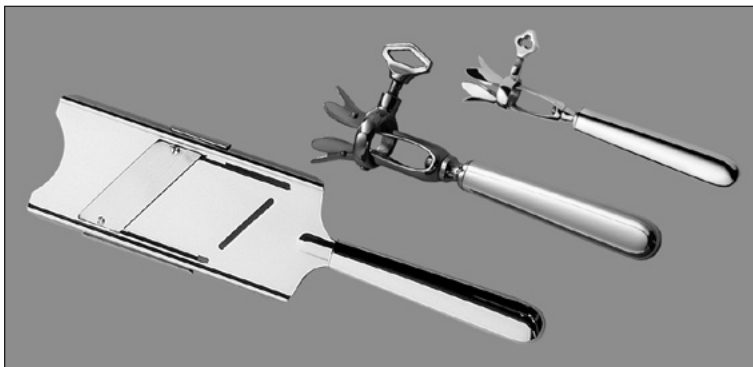

Drumstick clamp, small Pince à cuisse de caille Soporte de muslos de codorniz Pinza per piccione		06203387	06202387
Drumstick clamp, large Agarrador muslitos	Pince à gigot Pinza per gigot	06203388	06202388
Truffle slicer Cortador trufa	Rape à truffes Affetta tartufo	06203382	06202382

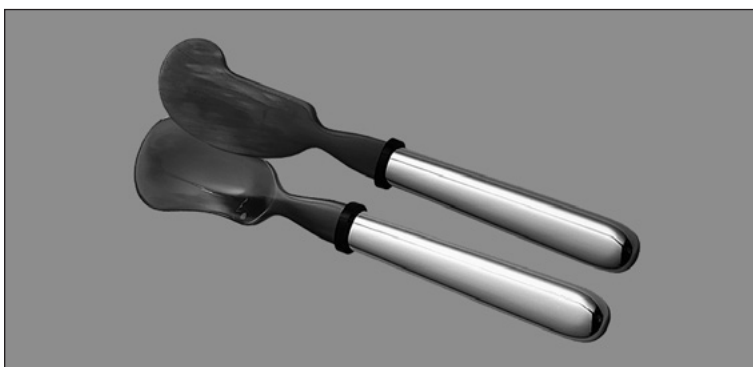

Caviar spoon Cuchara caviar	Cuiller à caviar Cucchiaio per caviale	06203380	06202380
Caviar knife Cuchillo caviar	Couteau à caviar Coltello per caviale	06203381	06202381

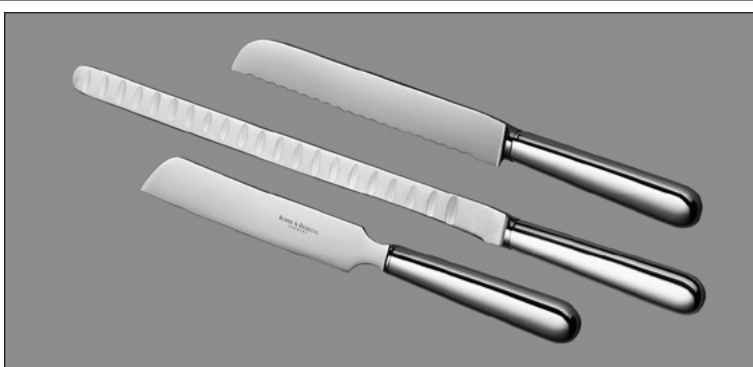

Bread knife Cuchillo de pan	Couteau à pain Coltello pane	06203379	06202379
Salmon carvin knife Couteau à découper le saumon Cuchillo de salmón Coltello salmone		06203359	06202359
Cake knife Cuchillo de tarta	Couteau à cake Coltello torta	06203393	06202393







	<p>Longdrink spoon Cuiller à longdrink Cuchara cocktail Cucchiario cocktail</p> <p>Martelé Dante</p>	<p>06303066 06203066</p>	<p>06302066 06202066</p>
	<p>Bottle-opener Ouvre-bouteille Abridor Apribottiglia</p> <p>Martelé Dante Belvedere Avenue Navette Navette* Französisch-Perl Französisch-Perl*</p>	<p>– 06203206 – 04403106 04803206 04803106 04603206 04603106</p>	<p>06302206 06202206 06802206 04402106 04802206 04802106 04602206 04602106</p>
	<p>Letter-opener Coupe-papier Abre-cartas Tagliacarte</p> <p>Dante Avenue Navette</p>	<p>06203201 04403101 04803201</p>	<p>06202201 04402101 04802201</p>
	<p>Magnifying glass Loupe Lupa Lente d'ingrandimento</p> <p>Dante Avenue</p>	<p>06203202 04403102</p>	<p>06202202 04402102</p>
	<p>Nutcracker Casse-noix Cascanueces Schiaccianoci</p> <p>Martelé Dante Belvedere</p>	<p>– 06203203 –</p>	<p>06302203 06202203 06802203</p>



Table accessories | Accessoires de table | Servicios de mesa | Accessori da tavola
 Gift items | Cadeaux | Artículos-regalo | Articoli da regalo

925
 Sterling
 Silver

90
 silver
 plated



Picture frame | Cadre
 Marco | Cornice

9 x 13 cm	22 x 17 cm	51003001 (150 g)	51001001
13 x 18 cm	22 x 17 cm	51003004 (110 g)	51001004



Picture frame, hatched
 Cadre, haché
 Marco, empollado
 Cornice, con tratteggio

9 x 13 cm	22 x 17 cm	51003002 (150 g)	51001002
13 x 18 cm	22 x 17 cm	51003003 (110 g)	51001003



Appetizer spoon
 Porte doucers
 Cuchara "Appetizer"
 Cucchiaino "Appetizer"

10 cm x 4 cm	51403015	51402015
--------------	----------	----------



Knife rest
 Porte-couteau
 Porta-cuchillos
 Supporto per coltello

Neutral	20003104	20002104
Alta	05003104	05002104





Chopsticks | Baguettes
 Palillos para comer | Bastoncini

japanese (short + pointed) chinese (long + blunt)
 japonais (court + pointu) chinois (long + contondant)
 japonés (corto + agudo) chino (largo + romo)
 giapponese (corto + punta) cinese (lungo + smussato)

Hokkaido (2x 50303013) Taishan (2x 50303023)
 Honshu (2x 50303011) Huashan (2x 50303021)
 Kyushu (2x 50303014) Songshan (2x 50303024)
 Shikoku (2x 50303012) Hengshan (2x 50303022)
 Osumi (2x 50303010) Huangshan (2x 50303020)

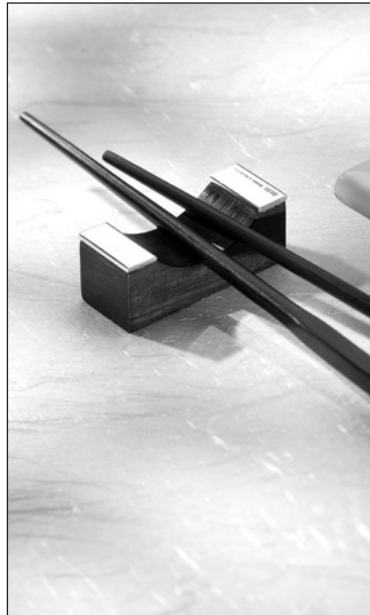

Chopstick rest
 Porte-baguettes
 Soporte de palillos para comer
 Supporto per bastoncini

large | grand
 grande | grande 50303029 -

small | petit
 pequeño | piccolo 50303019 -



EDO

Gourmet fork | Fourchette gourmet
 Forchetta gourmet | Tenedor gourmet 05403005 05402005

Gourmet knife | Couteau gourmet
 Cucchillo gourmet | Coltello gourmet 05403006 05402006

Gourmet spoon | Cuiller gourmet
 Cuchara gourmet | Cucchiaino gourmet 05403004 05402004

Dessert spoon | Cuiller à dessert
 Cuchara postre | Cucchiaino da dessert 05403007 05402007

Cutlery set, 4-piece (in a case)
 Couverts, lot de 4 (dans un étui)
 Cubiertos, juego de 4 piezas (en estuche)
 Posate, 4 pezzi (in astuccio) 05403,04,11 05402,04,11



Table accessories | Accessoires de table | Servicios de mesa | Accessori da tavola
 Gift items | Cadeaux | Artículos-regalo | Articoli da regalo

925
 Sterling
 Silver

90
 silver
 plated

<p>Alta</p> 	<p>Coffee pot Cafetière Cafetera Caffettiera</p> <p>1,3 l, Ø 11 cm, \bar{I} 17 cm</p>	<p>05003501 (770 g)</p>	<p>05001501</p>
<p>Alta</p> 	<p>Tea pot Théière Tetera Teiera</p> <p>1,3 l, Ø 14 cm, \bar{I} 12 cm</p>	<p>05003502 (660 g)</p>	<p>05001502</p>
<p>Alta</p> 	<p>Creamer Crémier Jarrita crema Bricchetto p.l.panna</p> <p>Sugar bowl Sucrier Azucarera Zuccheriera</p> <p>Tray Plateau Bandeja Vassoio</p> <p>Creamer and sugar set, 3-pieces Service de crème et de sucre Servicio de nata y azúcar Servizio di panna e zucchero</p> <p>Ø 5,8 cm, \bar{I} 6,1 cm</p> <p>Ø 8,1 cm, \bar{I} 4,2 cm</p> <p>22 x 14 cm</p>	<p>05003503 (140 g)</p> <p>05003504 (230 g)</p> <p>05003523 (330 g)</p> <p>05003,03,7 (700 g)</p>	<p>05001503</p> <p>05001504</p> <p>05001523</p> <p>05001,03,7</p>
<p>Alta</p> 	<p>Coffee and tea set, 4-pieces Service à café et à thé, 4 pcs. Juego de tazas de té y café, 4 piezas Servizio da tè e caffè, 4 pezzi large grand grande grande</p> <p>Tray Plateau Bandeja Vassoio</p> <p>Coffee and tea set, 5-pieces Service à café et à thé, 5 pcs. Juego de tazas de té y café, 5 piezas Servizio da tè e caffè, 5 pezzi</p> <p>Ø 36 cm</p>	<p>05003,04,25 (1,800 g)</p> <p>05003526 (1,075 g)</p> <p>05003,05,7 (2,875 g)</p>	<p>05001,04,25</p> <p>05001526</p> <p>05001,05,7</p>



<p>Alta</p> 	<p>Mocha pot Cafetière à moka Cafetera Caffettiera</p> <p>0,75 l, Ø 9,6 cm, \bar{I} 12 cm</p>	<p>05003505 (410 g)</p>	<p>05001505</p>
<p>Alta</p> 	<p>Tea pot Théière Tetera Teiera</p> <p>0,75 l, Ø 11,7 cm, \bar{I} 7,9 cm</p> <p>Stand for tea pot Dessous de théière Platillo para tetera Sottocaffettiera</p> <p>Ø 11,7 cm</p>	<p>05003506 (465 g)</p> <p>05003530</p>	<p>05001506</p> <p>05001538</p>
<p>Alta</p> 	<p>Mocha set, 3-pieces Service à moka, 3 pcs. Juego de tazas de moca, 3 piezas Servizio da moca, 3 pezzi</p> <p>Tray for mocha set Plateau à moka Bandeja para servicio Vassoio per servizio moca</p> <p>Ø 32 cm</p> <p>Mocha set, 4-pieces Service à moka, 4 pcs. Juego de tazas de moca, 4 piezas Servizio da moca, 4 pezzi</p> <p>including tray plateau compris incluye bandeja vassoio incluso</p>	<p>05003,03,9 (780 g)</p> <p>05003525 (790 g)</p> <p>05003,04,12 (1.570 g)</p>	<p>05001,03,9</p> <p>05001525</p> <p>05001,04,12</p>
<p>Alta</p> 	<p>Mocha and Tea set, 4-pieces Service à moka et à thé, 4 pcs. Juego de tazas de té y moca, 4 piezas Servizio da tè e moca, 4 pezzi</p> <p>Tray Plateau Bandeja Vassoio</p> <p>Ø 36 cm</p> <p>Mocha and Tea set, 5-pieces Service à moka et à thé, 5 pcs. Juego de tazas de té y moca, 5 piezas Servizio da tè e moca, 5 pezzi</p> <p>including tray plateau compris incluye bandeja vassoio incluso</p>	<p>05003,04,13 (1.245 g)</p> <p>05003526 (1.075 g)</p> <p>05003,05,8 (2.320 g)</p>	<p>05001,04,13</p> <p>05001526</p> <p>05001,05,8</p>



Table accessories | Accessoires de table | Servicios de mesa | Accessori da tavola
 Gift items | Cadeaux | Artículos-regalo | Articoli da regalo

925
 Sterling
 Silver

90
 silver
 plated

Alta



Warmer, 1 flame
 Réchaud à 1 feu
 Calienta - platos, 1 llama
 Scaldavivande a 1 fiamma

Ø 15,5 cm, I 6,5 cm

05003567
 (400 g)

05001567

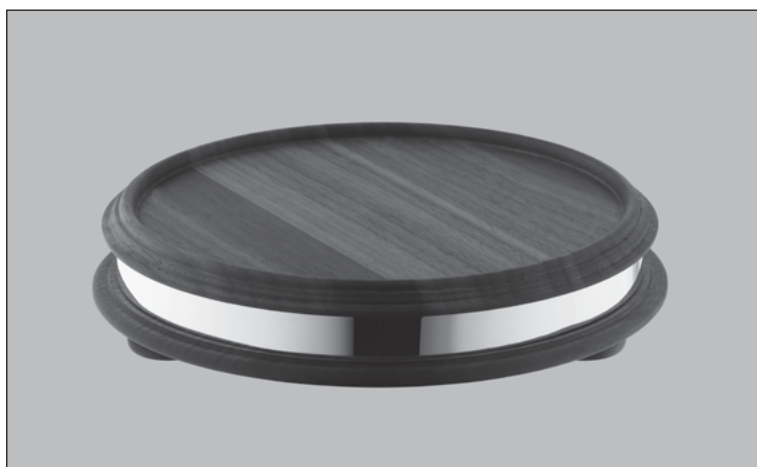

Nut tree coaster with silver setting
 Coaster en noyer avec bordure en argent
 Posavasos de nogal con engaste plateado
 Sottopiatto di legno di noce con bordo argentato
 Ø 16,5 cm
 I 3,5 cm

50803120

50801120



Revolving tea strainer
 Passoire à thé rotative
 Colador de té giratorio
 Setaccio da tè girevole

I ca. 4,5 cm
 Ø 6,5 cm
 I-I ca. 16,0 cm

50803115

50801115

Tea strainer with Corian handle & drip tray
 Passoire à thé – manche en Corian & l'égouttoir
 Colador de té – mango Corian & bandeja de goteo
 Setaccio da tè con manico Corian & sottovaso

I 3,5 cm
 Ø ca. 7,2 cm
 I-I ca. 13,0 cm

50803116

50801116

Alta

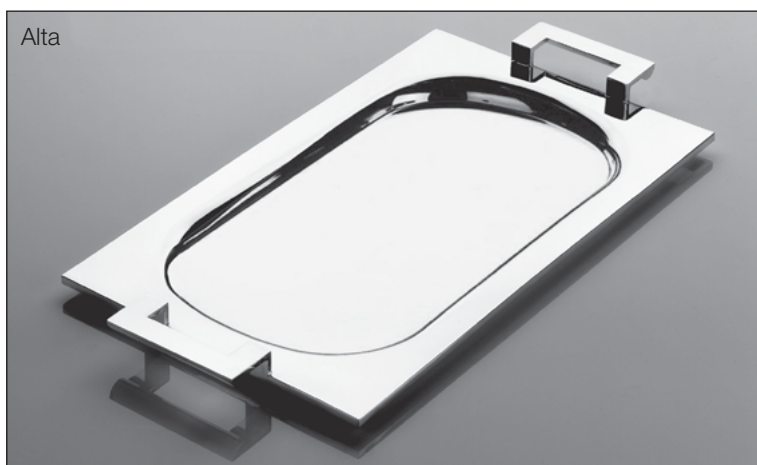

Tray
 Plateau
 Bandeja
 Vassoio

57 x 33 cm

05003529
 (3.130 g)

05001529

Wooden board (beech) 05001566
 Planche en bois (hêtre) 47 x 26 cm
 Tabla de madera (haya)
 Tavola di legno (faggio)



Alta



Tumbler Gobelet Vaso Bicchiere	Ø 6,8 cm, 6,5 cm	05003551 (130 g)	05001551
Tumbler Gobelet Vaso Bicchiere	Ø 6,4 cm, 5,5 cm	05003564 (120 g)	05001564
Tumbler, inside gold Gobelet, à l'intérieur doré Vaso con interior dorado Bicchiere con doratura interna	Ø 6,8 cm, 6,5 cm	05003550 (130 g)	05001550

Alta



Candlestick, with candle Chandelier, avec bougie Candelabro, con candela Candeliera con candela	5 cm	05003510 (150 g)	05001510
	12 cm	05003511 (180 g)	05001511
	16 cm	05003512 (200 g)	05001512

Alta



Salt-cellar Salero	Salière Saliera	05003560 (75 g)	05001560
Pepper-box Pimentero	Poivrier Pepaiola	05003561 (75 g)	05001561
Stand Soporto	Support Relat. piedi.	05003562 (90 g)	05001562
Cocktailstick Brocheta de cóctel	Broche à cocktail Forchettina per cocktail	05003099 (5 g)	05001099
Box Bote Contenitore	Boîte Houder	05003563 (65 g)	05001563



Love Spoons			
Love Spoon A		51403010	51402016
Love Spoon B		51403011	51402017



Table accessories | Accessoires de table | Servicios de mesa | Accessori da tavola
Gift items | Cadeaux | Artículos-regalo | Articoli da regalo

925
Sterling
Silver

90
silver
plated



Jam server tray, Martelé	31 x 21 cm	–	06301525
Plateau pour confiturier, Martelé			
Bandeja para botes de confitura, Martelé			
Vassoio per marmellata, Martelé			
Toast server tray, Martelé	21 x 17 cm	–	06301524
Plateau pour serveur de toast, Martelé			
Bandeja para soporte de tostada, Martelé			
Vassoio per toast, Martelé			
Jam server tray	31 x 21 cm	–	10001525
Toast server tray	21 x 17 cm	–	10001524
Toast server Serveur pour toast		–	50801111
Soporte de tostada Sostegno per toast			
Serving tray, Plateau de service	42 x 31 cm	10003526	10001526
Bandeja de servicio, Vassoio di servizio			
Serving tray, Plateau de service	28 x 19,5 cm	10003523	10001523
Bandeja de servicio, Vassoio di servizio			



Butter dish with silver-plated lid, Martelé	∅ 3 cm	–	06301104
Beurrier avec couvercle argenté, Martelé			
Mantequera con tapadera plateada, Martelé			
Burriera con coperchio in lega, Martelé			
Jam server with silver-plated lid, Martelé	∅ 5,8 cm	–	06301105
Confiturier avec couvercle argenté, Martelé			
Bote de confitura con tapadera plateada, Martelé			
Barattolo da marmellata con coperchio, Martelé			
Jam server with silver-plated lid, Martelé	∅ 8,8 cm	–	06301106
Confiturier avec couvercle argenté, Martelé			
Bote de confitura con tapadera plateada, Martelé			
Barattolo da marmellata con coperchio, Martelé			
Butter dish with silver-plated lid	∅ 3 cm	–	50801104
Jam server with silver-plated lid	∅ 5,8 cm	–	50801105
Jam server with silver-plated lid	∅ 8,8 cm	–	50801106



Vinegar/Oil bottle, Martelé	0,15 l, ∅ 17,5 cm	06303562	06301562
Vinaigre/Huile bouteille, Martelé		(50 g)	
Vinagre/Aceite botella, Martelé			
Aceto/Olio bottiglia, Martelé			
Salt-cellar, Martelé	Salière, Martelé	06303560	06301560
Salero, Martelé	Saliera, Martelé	(75 g)	
Pepper-box, Martelé	Poivrier, Martelé	06303561	06301561
Pimentero, Martelé	Pepaiola, Martelé	(75 g)	
Stand	Support	05003562	05001562
Soporto	Relat. piedi.	(90 g)	



Sugar bar Bar à sucre Barra para azúcar			
Barattolo di zuccheriera			
28 x 7,5 cm, ∅ 6 cm			
black, noir, negro, nero		50803003	50801003
cream, crème, crema, crema		50803018	50801018
Sugar spoon Cuiller à sucre Cuchara azúcar		05003023	05002023
Cucchiaio di zuccheriera			
Sugar bar cover	50801002	210,-	
Saltbar Bar à sel Bar para sal Saliera		50803010	50801001
19 x 6 cm, ∅ 4,5 cm			
Salt spoon Cuiller à sel Cuchara sal			
Cucchiaio sale			
Riva		06403074	06402074
Spaten (Image)		02003074	02002074
Metropolitan (o. Abb.)		07303074	07301074
Salt bar cover	50801302	189,-	



Bread-basket, large
 Corbeille à pain, grand
 Cesta para pan, grande
 Cestino pane, grande

Ø 20,0 cm 50801021

Bread-basket, small
 Corbeille à pain, petit
 Cesta para pan, pequeño
 Cestino pane, piccolo

Ø 14,5cm 50801020



Bread platter, large
 Planche à pain, grande
 Bandeja para pan, grande
 Vassoio portapane, grande
 *without fig. | sans photo | sin ilustración | z. afb. | senza fig.

40,0 x 12,0 cm 50801022

Bread platter, small
 Planche à pain, petite
 Bandeja para pan, pequeña
 Broodplank, klein
 Vassoio portapane, piccolo

24,0 x 12,0 cm 50801023



Butter dish with glass insert
 Beurrier avec insert en verre
 Tarro para mantequilla con apliques de cristal
 Portaburro con inserto di vetro

Ø 8,0 cm 50801024



Caviar box
 Boîte à caviar
 Tarro para caviar
 Scatola portacaviale

18,0 x 18,0 cm 50801034
 Ø 13,5 cm



Table accessories | Accessoires de table | Servicios de mesa | Accessori da tavola
 Gift items | Cadeaux | Artículos-regalo | Articoli da regalo

925
 Sterling
 Silver

90
 silver
 plated



Covered egg cup + salt shaker
 Coquetier avec chloche + salière
 Huevera con tapa y salero
 Portauovo con coperchio + saliera

50803005

50801007



Pastry tongs
 Pince à gâteaux
 Pinzas pastel
 Pinza per dolci

02003105

02002105

Spaten

04003105

04002105

Alt-Kopenhagen

01003105

01002105

Ostfriesen

01003105

01002105

Martelé



Pastry stand Alta
 Porte-Petits-Four Alta
 Etagère Alta
 Alzata Alta

14,5 cm

–

50801019

Pastry stand Martelé
 Porte-Petits-Four Martelé
 Etagère Martelé
 Alzata Martelé

14,5 cm

–

06301519



Cake stand, large
 Serviteur, grand
 Torre para platos, grande
 Alzata per piatti, grande
 Plates | Assiettes | Platos | Piatti ≤ 26,0 cm

49,0 cm

30,0 cm

–

50801110

Cake stand, middle
 Serviteur, moyen
 Torre para platos, media
 Alzata per piatti, media
 Plates | Assiettes | Platos | Piatti ≤ 19,0 cm

38,0 cm

23,0 cm

–

50801109

Cake stand, small
 Serviteur, petit
 Torre para platos, pequeña
 Alzata per piatti, piccola
 Plates | Assiettes | Platos | Piatti ≤ 16,0 cm

32,0 cm

19,0 cm

–

50801009

*without fig. | sans photo | sin ilustración | senza fig.



Leon



Salt mill Moulin à sel Molinillo de sal Macina sale	17,5 cm	17103563 (340 g)	17101563
Pepper mill Moulin à poivre Molinillo de pimienta Papaïola	17,5 cm	3.950,- (340 g)	2.450,-
Vinegar/Oil bottle Vinaigre/Huile bouteille Vinagre/Aceite botella Aceto/Olio bottiglia	0,15 l, 17,5 cm	17103562 (50 g)	17101562

Leon



Salt-cellar Salière Salero Saliera	7,5 cm	17103560 (80 g)	17101560
Pepper-box Poivrier Pimentero Pepaiola	7,5 cm	17103561 (80 g)	17101561

Leon



Tumbler Gobelet Vaso Bicchiere	0,22 l, 8,0 cm	17103583 (175 g)	17101583
Vase Vase Florero Vaso	1,36 l, 18,7 cm	17103551 (580 g)	17101551
Water pitcher Aiguière Jarra d'agua Caraffa	0,86 l, 28,5 cm	17103580 (590 g)	17101580

Penguin jugs
 Carafes pingouins
 Jarras de pingüino
 Bricchi Pinguino



large grand grande grande	1,3 l	17303580 (700 g)	17301580
small petit pequeño piccolo	0,5 l	17303581 (365 g)	17301581



Sphinx



Chocolate pot
Chocolatière
Chocolatera
Cioccolatiera

0,5 l, Ø 8,5 cm, \bar{I} 11,6 cm

06903508
(660 g)

06901508

Sphinx



Hot beverage pitcher
Aigüiere pour
boisson chaude
Bebida caliente
Brocca per bevanda calda

0,5 l, Ø 8,5 cm, \bar{I} 11,6 cm

06903509
(575 g)

06901509

Sphinx



Mocha Pot
Cafetière
Cafetera de moca
Caffettiera

0,5 l, Ø 8,5 cm, \bar{I} 11,6 cm

06903507
(560 g)

06901507

Sphinx



Water pitcher
Pot
Jarra
Brocca

1,0 l, Ø 10,5 cm, \bar{I} 13,8 cm

06903580
(830 g)

06901580



Sphinx



Wine tumbler
 Gobelet à vin
 Vaso de vino
 Bicchiere da vino

Ø 7,0 cm, H 7,2 cm

06903582
 (ca. 165 g)

06901582

Water tumbler
 Gobelet à eau
 Vaso de agua
 Bicchiere per l'acqua

Ø 7,5 cm, H 9,5 cm

06903583
 (ca. 200 g)

06901583

Vodka beaker
 Coupe à vodka
 Vaso para vodka
 Bicchiere per vodka

Ø 4,7 cm, H 5,0 cm

06903581
 (ca. 65 g)

06901581

Sphinx

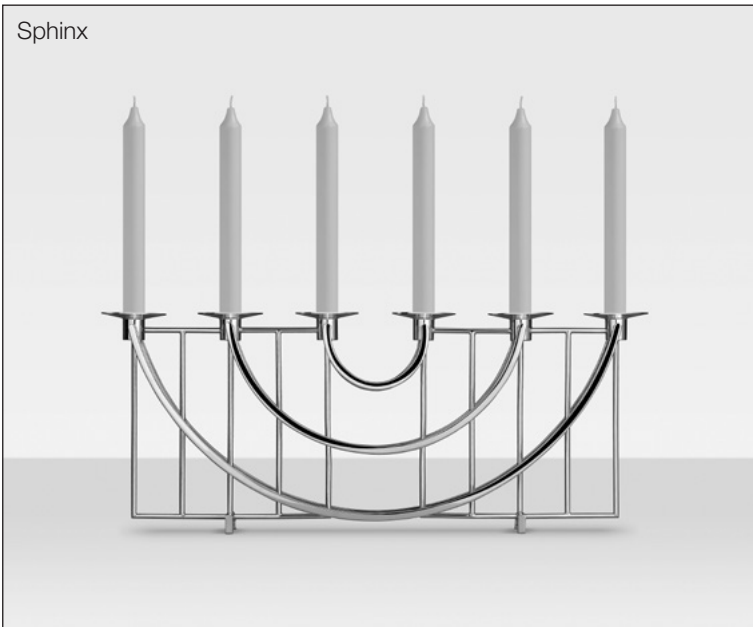

Candelabra, 6 branches
 Chandelier, 6-branches
 Candelabro, 6 buijas
 Candeliere, 6-luci

H 23,5 cm, L 60,0 cm

06903513
 (ca. 2.450 g)

06901513

Sphinx



Candelabra, 3 branches
 Chandelier, 3-branches
 Candelabro, 3 buijas
 Candeliere, 3-luci

H 20,0 cm

06903514
 (810 g)

06901514

Candlestick | Chandelier
 Candelabro | Candeliere

H 16,0 cm

06903512
 (310 g)

06901512

Candlestick | Chandelier
 Candelabro | Candeliere

H 12,0 cm

06903511
 (275 g)

06901511

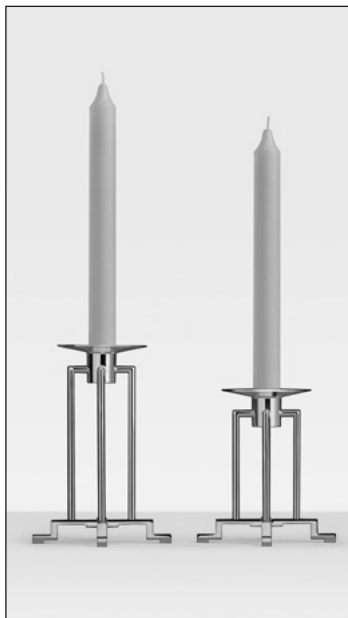



Grande Composition
(a pair of candleholders | une paire de chandeliers
Par de candeleros | Coppia di candelabri)

Price per candleholder
Prix par chandelier
Precio por candelero
Prezzo cadauno

17603510
(ca. 540 g)

17601510

Dimensions | Dimensions
Medida | Misure

36 x 8,6 x 15,6 cm

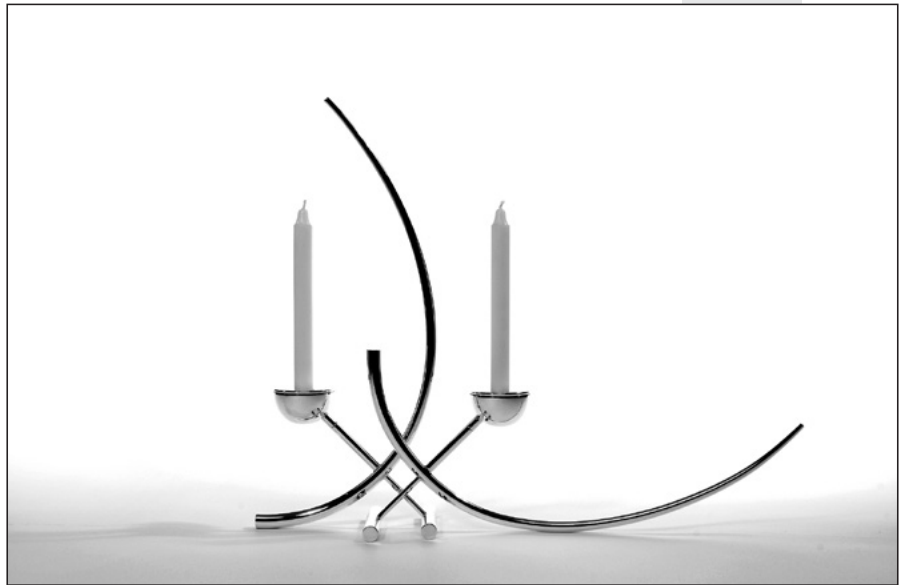

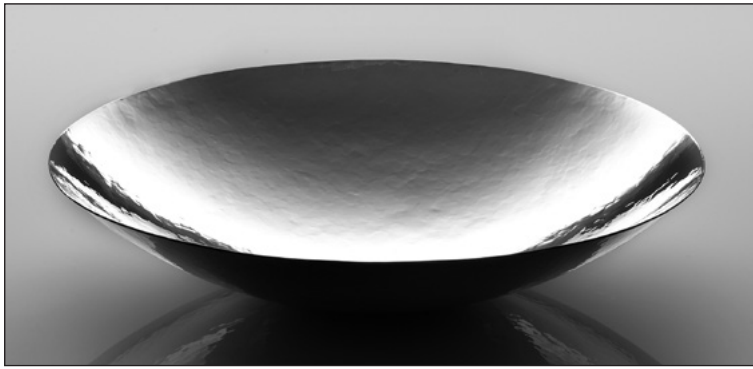

Bowl Hermitage
 Jatte Hermitage

Ø 22,0 cm, \bar{I} 4,5 cm

07003540
 (328 g)

07001540



Bowl | Jatte | Bol | Coppa

Jan von Borstel

Ø 47 cm

17203045
 (5.700 g)

17201045



Large bowl
 Grande jatte
 Fuente grande
 Coppa grande

38,5 x 50,5 cm, \bar{I} 13,5 cm

05003545
 (2.020 g)

05001545

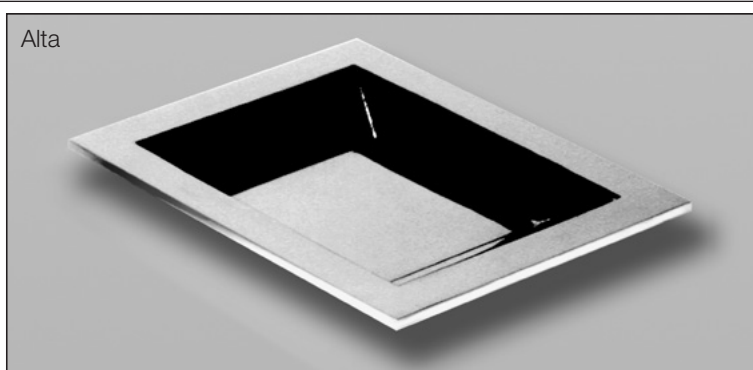

Rectangular bowl
 Jatte, rectangular
 Bol, rectangular
 Coppa rettangolare

17 x 14 cm
 \bar{I} 1,85 cm

05003546
 (335 g)

05001546



Bowl | Jatte
 Bol | Coppa

Ø 10,0 cm, \bar{I} 5,0 cm

06303540
 (50 g)

06301540

Bowl | Jatte
 Bol | Coppa

Ø 12,0 cm, \bar{I} 6,0 cm

06303541
 (80 g)

06301541



Table accessories | Accessoires de table | Servicios de mesa | Accessori da tavola
 Gift items | Cadeaux | Artículos-regalo | Articoli da regalo

925
 Sterling
 Silver

90
 silver
 plated

Alt-Kopenhagen



Bowl
 Jatte
 Bol
 Coppa

39 x 17 cm

04003541
 (700 g)

04001541

Alt-Kopenhagen



Basket, with handle
 Panier à anses
 Cesta, con asas
 Coppa con manico

29,5 x 17 cm, \bar{I} 23,5 cm

04003540
 (710 g)

–

Alt-Kopenhagen



Alt-Kopenhagen



Candlestick | Chandelier
 Candelabro | Candeliere

04003509

04001509

Box for toothpicks
 Boîte de cure-dents
 Palillero
 Scatola per stuzzicadenti

Ø 4 cm, \bar{I} 6 cm

04003563

04001563

Candelabra, 2 branches
 Chandelier, 2 branches
 Candelabro, 2 bujías
 Candeliere, 2 luci

\bar{I} 21,5 cm

04003510
 (600 g)

04001510

Bottle cap
 Bouchon
 Tapón
 Tappo per bottiglia

04003562

04001562

Alt-Kopenhagen



Candelabra, 5 branches
 Chandelier, 5 branches
 Candelabro, 5 bujías
 Candeliere, 5 luci

\bar{I} 21 cm

04003511
 (1.090 g)

04001511



Alt-Augsburg



Coffee pot
 Cafetière
 Cafetera
 Caffettiera

1,5 l, Ø 15 cm, \bar{I} 22 cm

10103501
 (670 g)

10101501

Tea pot
 Théière
 Tetera
 Teiera

1,3 l, Ø 15 cm, \bar{I} 19 cm

10103502
 (670 g)

10101502

Alt-Augsburg



Creamer, inside gold
 Crémier, à l'intérieur doré
 Jarrita crema, con interior dorado
 Bricchetto con doratura interna

10103503
 (170 g)

10101503

Sugar bowl, with cover, inside gold
 Sucrier, avec couvercle, à l'intérieur doré
 Azucarera, con tapa, con interior dorado
 Zuccheriera con coperchio e doratura interna

10103504
 (190 g)

10101504

Tray
 Plateau
 Bandeja
 Vassoio

26 x 18 cm

10103523
 (420 g)

10101523

Alt-Augsburg



Tray
 Plateau
 Bandeja
 Serveerblad
 Vassoio

42 x 31 cm

10103526
 (1.500 g)

10101526

Alt-Augsburg



Jug, inside gold
 Pot, à l'intérieur doré
 Jarra, con interior dorado
 Brocca con doratura interna

1,5 l, Ø 14,5 cm, \bar{I} 17 cm

10103507
 (490 g)

10101507

Tumbler, inside gold
 Gobelet, à l'intérieur doré
 Vaso, con interior dorado
 Bicchiere con doratura interna

\bar{I} 9,5 cm

10103550
 (135 g)

10101550

Bottle cap
 Bouchon
 Tapón
 Tappo per bottiglia

10103562

10101562



Alt-Augsburg



Candlestick
Chandelier, 1 branche
Candelabro, 1 bujía
Candeliere, 1 luce

19 cm

10103510
(120 g)

10101510

Alt-Augsburg



Candelabra, 3 branches
Chandelier, 3 branches
Candelabro, 3 bujías
Candeliere, 3 luci

27 cm

10103511
(350 g)

10101511

Candelabra, 5 branches
Chandelier, 5 branches
Candelabro, 5 bujías
Candeliere, 5 luci

27 cm

10103512
(460 g)

10101512

Alt-Augsburg



Candelabra, 7 branches
Chandelier, 7 branches
Candelabro, 7 bujías
Candeliere, 7 luci

56 cm

10103513
(3.030 g)

10101513



Empire



Candlestick
 Chandelier
 Candelabro
 Candeliera

12 cm

10403511
 (98 g)

-

Candlestick
 Chandelier
 Candelabro
 Candeliera

15,5 cm

10403512
 (116 g)

Empire



Candelabra, 9 branches
 Chandelier, 9 branches
 Candelabro, 9 bujias
 Candeliera, 9 braccia

74 cm

10403510
 (4.200 g)

10401510



Table accessories | Accessoires de table | Servicios de mesa | Accessori da tavola
 Gift items | Cadeaux | Artículos-regalo | Articoli da regalo

925
 Sterling
 Silver

90
 silver
 plated

Kordelrand



Jug Pot Jarra Brocca	1,2 l, Ø 14 cm, 16 cm	10203507 (520 g)	10201507
Tumbler, inside gold Gobelet, à l'intérieur doré Vaso, con interior dorado Bicchiere con doratura interna	Ø 7,5 cm, 8,5 cm	10203550 (170 g)	10201550

Kordelrand



Vase Vase Florero Vaso	Ø 7 cm, 8 cm	10203551 (85 g)	10201551
Vase Vase Florero Vaso	Ø 14 cm, 16 cm	10203552 (520 g)	10201552

Kordelrand



Bowl Jatte Bol Coppa	Ø 21 cm, 9 cm	10203541 (640 g)	10201541
Bowl* Jatte Bol Coppa	Ø 15 cm, 6 cm	10203540 (310 g)	10201540
Bread-basket Corbeille à pain Cesta para pan Cestino pane	26,5 x 19,5 cm	10203542 (430 g)	10201542

*without fig. | sans photo | sin ilustración | senza fig.

Kordelrand



Butter dish, with cover Beurrier, avec couvercle Mantequera, con tapa Burriera con coperchio	16,5 x 12,5 cm	10203544 (360 g)	10201544
Box, with cover, inside gold Bonbonnière, avec couvercle, à l'intérieur doré Bombonera, con tapa, con interior dorado Scatola per caramelle con coperchio e doratura interna	Ø 12 cm, 9 cm	10203543 (250 g)	10201543



Crystal bowl with silver cover and silver trimming Ø 14 cm 50803030 (120 g) 50801033

Coupe de cristal avec couvercle d'argent et garniture d'argent

Caja con tapa de plata y adornos de plata

Coppa cristallo con coperchio argento e decorazione in argento



Caviar bowl with silver cover and silver trimming Ø 17 cm 50803031 (210 g) 50801031

Coupe à caviar avec couvercle d'argent et garniture d'argent

Fuente para caviar con tapa de plata y adornos de plata

Coppa caviale con coperchio argento e decorazione in argento



Set Sylt Oyster | Set Huître Sylt
 Juego ostra de Sylt | Set ostrica di Sylt 51403032 51402032

Set Sylt Oyster | Set Huître Sylt
 Juego ostra de Sylt | Set ostrica di Sylt (inside gold | à l'intérieur doré con interior dorado | con doratura interna) 51433032 51432032

consistant | comprenant
 consistiendo en | consiste di:

1 Sylt Oyster | 1 Huître Sylt
 1 Ostra de Sylt | 1 ostrica di Sylt

1 Salt spoon Riva | 1 Cuiller de sel Riva
 1 Cuchara de sal Riva | 1 cucchiaino da sale Riva

Sea Salt | Sel marin
 Sal marina de Sylt | Sale marino di Sylt

Wooden tray | Plateau en bois
 Bandeja de madera | Vassoio di legno

Booklet | Livret | Folleto | Brochure

Gift box | Coffret-cadeau | Estuche | Astuccio



Chess | échecs | el ajedrez | gli scacchi

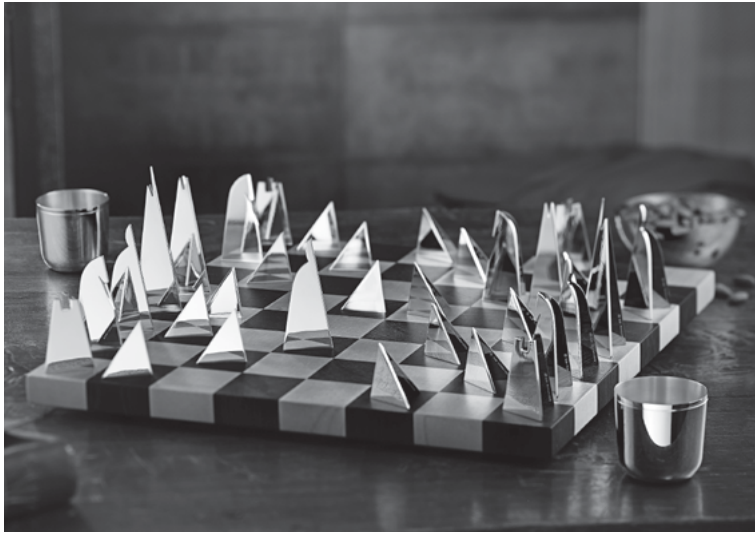

Chess | échecs | el ajedrez | gli scacchi

51503000

consistant | comprenant | consiendiendo en | consiste di:

16x Chess piece, 925/000 | 16x Pièce d'échecs, 925/000
16x Pieza de ajedrez, 925/000 | 16x Figura degli scacchi, 925/000

16x Chess piece, 925/000, gilded | 16x Pièce d'échecs, 925/000, doré
16x Pieza de ajedrez, 925/000, dorada | 16x Figura degli scacchi, 925/000, dorato

1x Chessboard maple and wengé | 1x L'échiquier érable et wengé
1x Tablero de ajedrez arce y wengé | 1x Scacchiera legno acero e wengé

1x Tumbler, 925/000, inside gold | 1x Gobelet, 925/000, à l'intérieur doré
1x Vaso, 925/000, con interior dorado | 1x Bicchiere, 925/000, con doratura interna

1x Tumbler, 925/000, outside gold | 1x Gobelet, 925/000, à l'extérieur doré
1x Vaso, 925/000, con exterior dorado | 1x Bicchiere, 925/000, con doratura esterna

1x Leather etui | 1x Etui en cuir | 1x Caja de cuero | 1x Astuccio in pelle

Chess | échecs | el ajedrez | gli scacchi

51501000

90 silver plated

Chess pieces also available in platinum (Pt960) and gold (Au999). Price upon request.

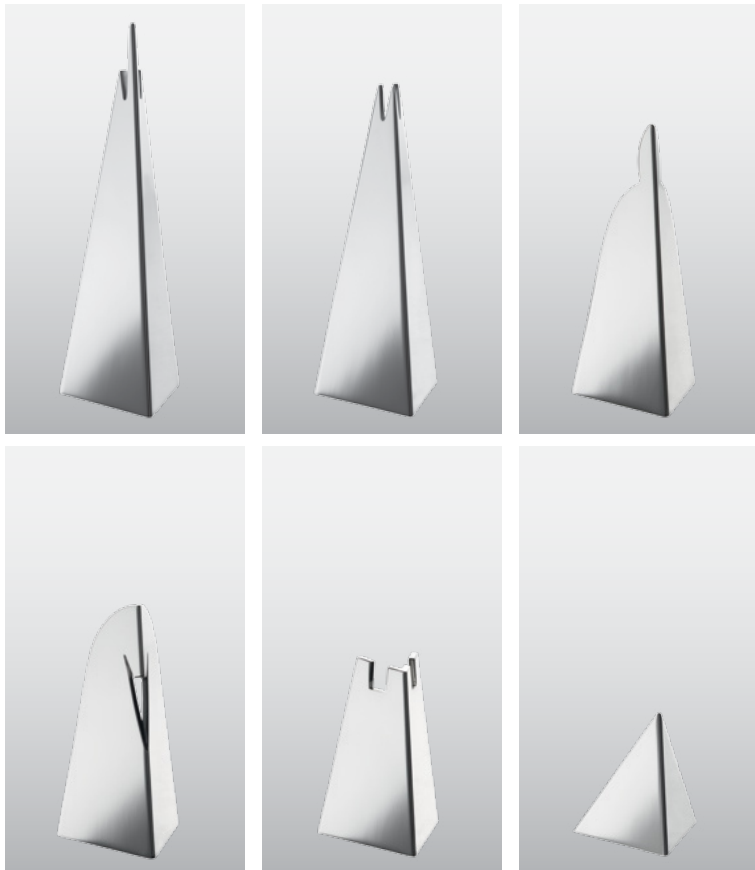

Chess pieces Pièces d'échecs Piezas de ajedrez Pezzo degli scacchi	👑 925 Sterling Silver	👑 925 Sterling Silver gilded	90 silver plated	90 silver plated gilded
King Roi Rey Re ⏴ 12,5 cm, ⏳ 4 cm	51503001	51543001	51501001	51541001
Queen Dame Reina Regina ⏴ 10,2 cm, ⏳ 4 cm	51503002	51543002	51501002	51541002
Bishop Fou Alfil Alfiere ⏴ 9,0 cm, ⏳ 4 cm	51503004	51543004	51501004	51541004
Knight Cavalier Caballo Cavallo ⏴ 7,9 cm, ⏳ 4 cm	51503005	51543005	51501005	51541005
Rook Tour Torre Torre ⏴ 5,8 cm, ⏳ 4 cm	51503003	51543003	51501003	51541003
Pawn Pion Peón Pedone ⏴ 4,4 cm, ⏳ 4 cm	51503006	51543006	51501006	51541006

Chess pieces also available in platinum (Pt960) and gold (Au999). Price upon request.

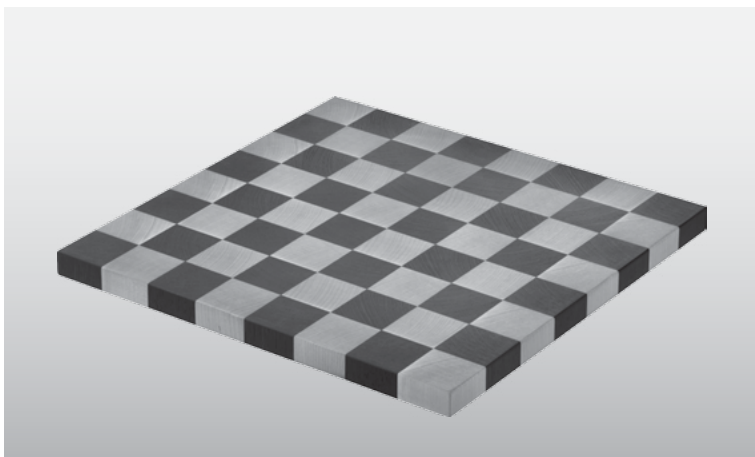

Chessboard

51508001

L'échiquier
Tablero de ajedrez
Scacchiera

Handcrafted from maple and wengé
Fait à la main d'érable et de wengé
Hecho a mano de arce y wengue
Fatto a mano di acero e wengé

Dimensions | Dimensions | Medida | Misure

↔ 44 cm
↕ 44 cm
⏴ 3 cm



Checkers game | Jeu de dames | Damas | Dama

51501011

12 white tokens
12 black tokens
Game board, handcrafted from maple and wenge
Leather game case

12 pions blancs
12 pions noirs
Plateau de jeu, fabriqué à la main en érable et wengé
Etui de jeu en cuir

12 fichas blancas
12 fichas negras
Tablero de juego, hecho a mano de arce y wengué
Estuche de juego de cuero

12 pedine bianche
12 pedine nere
Tabellone di gioco, realizzato a mano in acero e wengé
Custodia in pelle per il gioco



Tic-Tac-Toe | Jeu de Tic Tac Toe | Tres en raya | Il tris con tavoliere

51501012

5 "X"
5 "O"
Game board, handcrafted from maple and wenge
Leather game case

5 pions «X»
5 pions «O»
Plateau de jeu, fabriqué à la main en érable et wengé
Etui de jeu en cuir

5 fichas «X»
5 fichas «O»
Tablero de juego, hecho a mano de arce y wengué
Estuche de juego de cuero

5 pedine "X"
5 pedine "O"
Tabellone di gioco, realizzato a mano in acero e wengé
Custodia in pelle per il gioco

Case with playing cards
Etui avec cartes à jouer
Estuche con cartas
Astuccio con carte da gioco

54501020

Robbe & Berking playing card set (55 cards)
Jeu de cartes à jouer Robbe & Berking (55 cartes)
Juego de cartas Robbe & Berking (55 cartas)
Set di carte da gioco Robbe & Berking (55 carte)

Dice cup
Gobelet à cubes
Vaso de dados
Tazza per i dadi

51501021

with 6 dice
avec 6 cubes
con 6 dados
con 6 dadi



Service plates and trays | Assiettes et plateaux
Platos y bandejas | Piatti e vassoi

925
Sterling
Silver

90
silver
plated

Trays



Alt-Spaten



Alt-Faden



Service plates



Alta



Alt-Spaten

Französisch-Perl



Alt-Faden



Bottle-coasters



Alta



Alt-Spaten



Französisch-Perl



Alt-Faden



Martelé

Coasters



Alta



Alt-Spaten



Französisch-Perl



Alt-Faden



Martelé

Tray
Bandeja para vasos

Plateau
Vassoio per bicchieri

Alta Ø 40 cm	05003519 (1.623 g)	05001519
Alta Ø 36 cm	05003526 (1.075 g)	05001526
Alt-Spaten Ø 30 cm	01903526 (675 g)	01901526
Alt-Faden Ø 30 cm	04503526 (770 g)	04501526

Service plate
Plato servir

Assiette de présentation
Sottopiatto segnaposto

Alta Ø 30 cm	05003524 (660 g)	05001524
Alta Ø 32 cm	05003525 (750 g)	05001525
Alt-Spaten Ø 30 cm	01903524 (620 g)	01901524
Französisch-Perl Ø 30 cm	04603524 (720 g)	04601524
Alt-Faden Ø 30 cm	04503524 (700 g)	04501524

Bottle-coaster
Posabotella

Sous-bouteille
Sottobottiglia

Alta Ø 14,5 cm	05003521 (115 g)	05001521
Alt-Spaten Ø 13,5 cm	01903521 (94 g)	01901521
Französisch-Perl Ø 13,5 cm	04603521 (125 g)	04601521
Alt-Faden Ø 13,5 cm	04503521 (94 g)	04501521
Martelé Ø 14,5 cm	–	06301521

Coaster
Posavaso

Sous-verre
Sottobicchiere

Alta Ø 11,5 cm	05003520 (97 g)	05001520
Alt-Spaten Ø 10,5 cm	01903520 (55 g)	01901520
Französisch-Perl Ø 10,5 cm	04603520 (55 g)	04601520
Alt-Faden Ø 10,5 cm	04503520 (55 g)	04501520
Martelé Ø 11,5 cm	–	06301520

X-Mas/Easter decorations | Décorations de Noël/Pâques
Adornos de Navidad/Pascua | Decorazioni di Natale/Pasqua



925
Sterling
Silver

silver
plated
argenté
bañado en
plata
argentato



1 Snowman | Bonhomme de neige
Muñeco de nieve | Pupazzo de neve

2 Advent wreath | Couronne de l'advent
Corona di adventio | Corona d'avento

3 X-mas tree 1 | Arbre de noel 1
Arbol de navidad 1 | Albero di Natale 1

4 X-mas tree 2 | Arbre de noel 2
Arbol de navidad 2 | Albero di Natale 2

5 Aviary | Volière
Nido de pajaros | Uccelliera

6 Sheaf | Gerbe | Govilla | Covone

7 Ice cristal 1 | Cristal à glace 1
Cristal de hielo 1 | Cristallo di ghiaccio 1

8 Ice cristal 2 | Cristal à glace 2
Cristal de hielo 2 | Cristallo di ghiaccio 2

9 Pair of dwarfs 1 | Pair de gnome 1
Pareja enanos 1 | Paio di gnomi 1

10 Pair of dwarfs 2 | Pair de gnome 2
Pareja enanos 2 | Paio di gnomi 2

Easter Ornaments | Decoration de paques
Adornos arbol de pascua | Collezione di pasqua

11 2 Small chicken | 2 Poussin
2 Pájari | 2 Pulcini*

12 4 Small chicken | 4 Poussin
4 Pájari | 4 Pulcini*

– 51201022

– 51201023

– 51201024

– 51201032

– 51201025

– 51201026

– 51201027

– 51201033

– 51201028

– 51201029

– 51201030

– 51201031



Table candle stick | Bougeoir de table
Candelabro de mesa | Candeliera da tavola

X-mas tree | Arbre de noel
Arbol de navidad | Albero di Natale

Moon | Lune | Luna | Luna

Angel | Ange | Angel | Angelo

Star | Etoile | Estella | Stella*

Bell | Cloche | Campanilla | Campana

Heart | Coeur | Corazón | Hart | Cuore

Dove | Pigeon | Paloma | Duif | Colomba*

*without fig. | sans photo | sin ilustración | senza fig.

51203003 51201003

51203001 51201001

51203002 51201002

51203005 51201005

51203004 51201004

51203007 51201007

51203006 51201006



Coats of arms | Armes | Escudos | Armi



Mercedes-Benz



Types | Lettres | Tipos de letra | Tipi di carattere

Englische Schreibrschrift

Antiqua

Blockschrift

Fraktur

Engraving signature | Nom gravé | Grabados de un nombre | Nome inciso

Engraving per character depending on size and volume of order (at least 3 letters)

1 lettre en texte courant selon taille et quantité (au moins 3 lettres)

Cada letra de texto corrido, en función del tamaño y del volumen del encargo (al menos 3 letras)

Incisione per carattere a seconda delle dimensioni e del volume dell'ordine (almeno 3 lettere)

Monograms | Monogrammes | Monogramas | Monogrammi



1



2



3



4



5



6



7



8



9



10



11



12

Customised knife blades | Lames de couteau personnalisées
Hojas de cuchillo personalizadas | Lame di coltello personalizzate

Attention to detail: With a new technology, Robbe & Berking offers you the possibility to individualise menu and steak knife blades – e.g. with the logo of your restaurant, your family crest, facsimile or the silhouette of your yacht. The Robbe & Berking logo is positioned on the reverse of the blade. We offer this option for Martelé, Riva and Belvedere blades in shiny and “Frozen Black” finishes. Make your knives unique.

Attention au détail: Grâce à une nouvelle technologie, Robbe & Berking vous offre la possibilité d’individualiser les lames des couteaux à menu et à steak – par exemple avec le logo de votre restaurant, le blason de votre famille, un fac-similé ou la silhouette de votre yacht. Le logo de Robbe & Berking est placé au dos de la lame. Nous proposons cette option pour les lames Martelé, Riva et Belvedere en finition brillante et «Frozen Black». Créez vos couteaux uniques.

Laser Cut examples | Laser Cut exemples | Laser Cut ejemplos | Laser Cut esempi



Marble cut example | Marble cut exemple | Marble cut ejemplos | Marble cut esempi



**Laser Cut Individualizations | Personnalizations par Laser Cut | Individualizaciones Laser Cut
Laser Cut Individualisations | Individualizzazioni con Laser Cut**

If the desired motif is available as a vector file.

Si le motif souhaité est disponible sous forme vectoriel.

Si el motivo deseado está disponible como archivo vectorial.

Se il motivo desiderato è disponibile come file vettoriale.

EURO 25,-

Without vector file the price is on request. | Sans fichier vectoriel, le prix est sur demande.

Sin archivo vectorial el precio es a petición. | Senza file vettoriale il prezzo è su richiesta.

(The Robbe & Berking lettering is on the reverse of the knife. | L’inscription Robbe & Berking se trouve au dos du couteau.

La inscripción Robbe & Berking está en el reverso del cuchillo. | La scritta Robbe & Berking si trova sul retro del coltello.)

**Marble Cut Individualisations | Personnalizations Marble Cut
Individualizaciones Marble Cut | Individualizzazioni Marble Cut**

Available in the Martelé, Belvedere and Riva collections. | Disponible dans les collections Martelé, Belvedere et Riva.

Disponibile en las colecciones Martelé, Belvedere y Riva. | Disponibile nelle collezioni Martelé, Belvedere e Riva.

Marble Cut laser engraving

Marble Cut gravure au laser

Grabado por láser Marble Cut

Incisione laser Marble cut

EURO 30,- per knife (plus knife price)

EURO 30,- par couteau (prix du couteau en plus)

EURO 30,- por cuchillo (más el precio del cuchillo)

EURO 30,- per coltello (più il prezzo del coltello)

Reparation | Réparations | Reparaciones | Riparazione

New blade – knife incl. insertion and polishing Nouvelle lame – échange et polissage Nueva hoja de cuchillo incl. la labor de engaste Nuovo lama per coltello, compreso l'incastro	0307010	44,-
New blade – insertion and complete reworking of the knife Nouvelle lame – échange et retravailler du couteau Nueva hoja – la labor de engaste e il ritrattamento del coltello Nuovo lama – compreso l'incastro y el reacondicionamiento de cuchillo	0307011	82,-
New blade – tart knife/carving knife – incl. insertion and polishing Nouvelle lame – couteau à tarte/couteau à découper – échange et polissage Nueva hoja – cuchillo tarta/cuchillo trincar incl. la labor de engaste Nuovo lama – coltello torta/coltello trinciante, compreso l'incastro	0307020	60,-
New blade – tart knife/carving knife – insertion and complete reworking Nouvelle lame – couteau à tarte/couteau à découper – échange et retravailler Nueva hoja – cuchillo tarta/cuchillo trincar – la labor de engaste e il ritrattamento Nuovo lama – coltello torta/coltello trinciante – compreso l'incastro y el reacondicionamiento	0307021	96,-
Polishing of blade Polissage d'une lame Pulir la hoja Lucidare della lama	0307070	11,-
Serration of blade Transformation en lame-scie Poner sierra a la hoja Aggiungere lama con sega	0307040	10,-
Removing of serration and polishing of blade Enlever la scie et aiguisage de lame Retirar la sierra y afilar la hoja Rimuovere della sega e la rettifica della lama	0307050	14,-
Finishing (Grinding/pre-polishing/electro-plating/polishing) Remise en état (aiguisage, polissage, argenter) Reacondicionar (afilarse/pulir/baño plata/repulir) Finire (Rettificare, pulire, argentare, lucidare)		
Table / menu / dessert size Pièces en taille table/menu/dessert Tamaño de la mesa, del menú y del postre Tabella- / menu- / dimensione del dessert	0307130	48,-
Cutlery pieces smaller than dessert size Pièces plus petites que la taille dessert Piezas de cubiertos más pequeñas que el tamaño del postre Pezzi di posate più piccoli del formato del dessert	0307120	31,-
Serving pieces Pièces à servir Piezas de servir Posate da servire	0307160	73,-
Soup ladle, asparagus server, serving spoon Louche, pelle/pince à asperges, cuiller à servir Cucharón de sopa, pala de espárragos, cuchara de servicio Mestolo da zuppa, pala per asparagi, cucchiaino da portata	0307140	122,-
1 piece of cutlery, only polishing Polissage de couverts par pièce pulido de cubiertos, por pieza 1 pezzo singolo, solo lucidare	0307110	14,-

MATERIAL & QUALITIES

Robbe & Berking cutlery is manufactured through all quality groups out of the respectively best materials. The sophisticated and detailed manufacturing quality is unsurpassed worldwide.

925 Sterling Silver

925 sterling silver is the internationally-acknowledged and most valuable silver alloy. It consists to 92.5 % of fine silver and to 7.5 % of fine copper.

150 g massive silver plated

Cutlery is subjected to far greater stresses than tableware. The 150 g solid silver plating on cutlery is a development from the Robbe & Berking laboratory which has now become widespread. It is characterised by a silver coating which is two thirds thicker than the still widely-used 90 g silver plating. Instead of 90 g of fine silver, 150 g are applied to a surface of 24 dm². This coating is the prerequisite for an extremely high wear resistance and a long lifetime.

ROBBE & BERKING
— S I L B E R —

Robbe & Berking Silbermanufaktur seit 1874 GmbH & Co. KG
Zur Bleiche 47 · D-24941 Flensburg · Germany
Telephone +49 (0)461 / 90 30 60 · Fax +49 (0)461 / 90 30 6-22

info@robbeberking.com
www.robbeberking.com

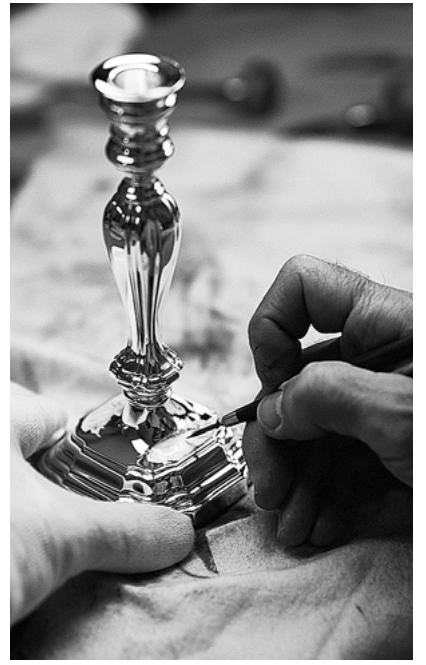

ROBBE & BERKING
— SILBER —

WWW.ROBBEBERKING.COM